

Maßstab	Gez.	05.11.09	DI
	1:1		
	Gepr.		
	%		
K-Name: ALBRECHT			
K-Nr.: . . .			
4 09 262 040 A			

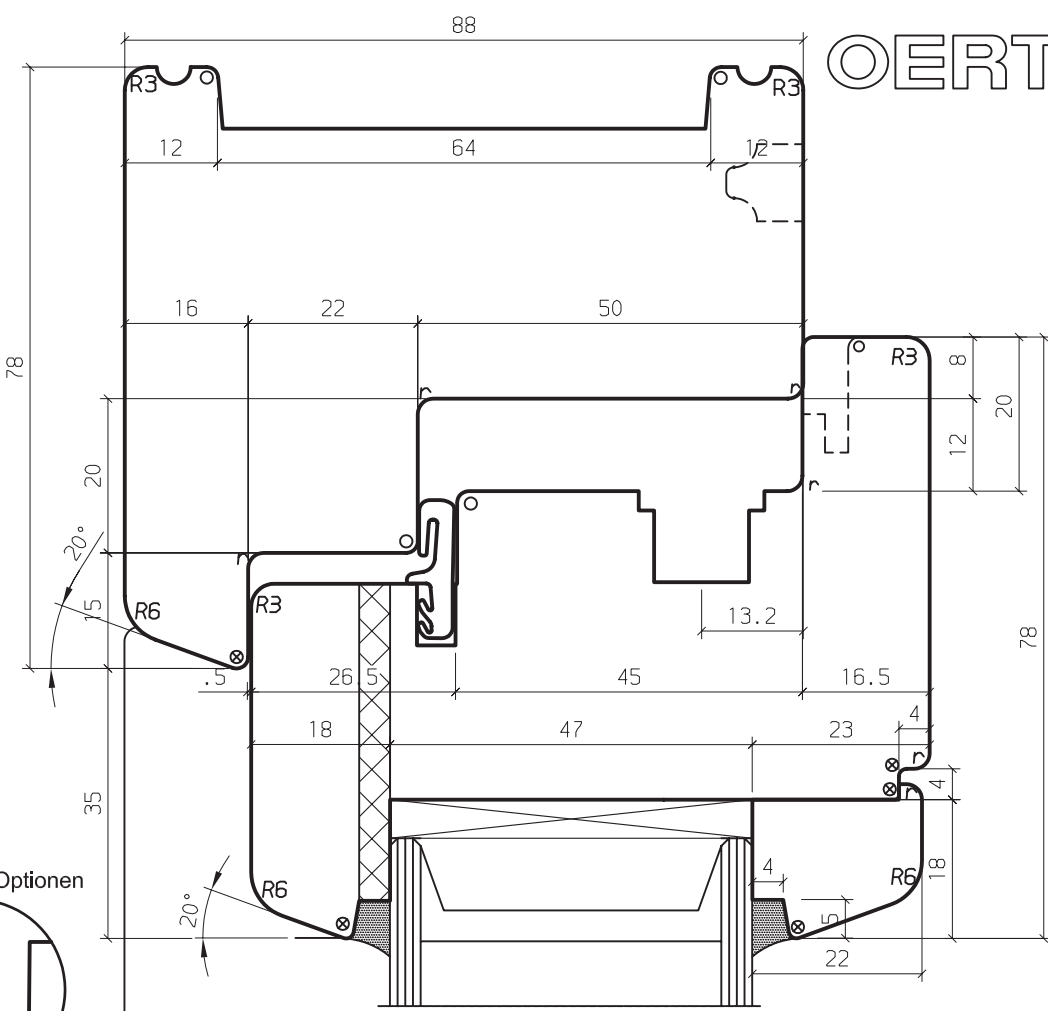

zusätzliche Optionen

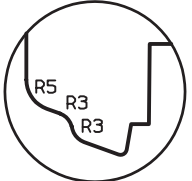

Rustikal Profil am Flügel

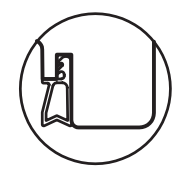
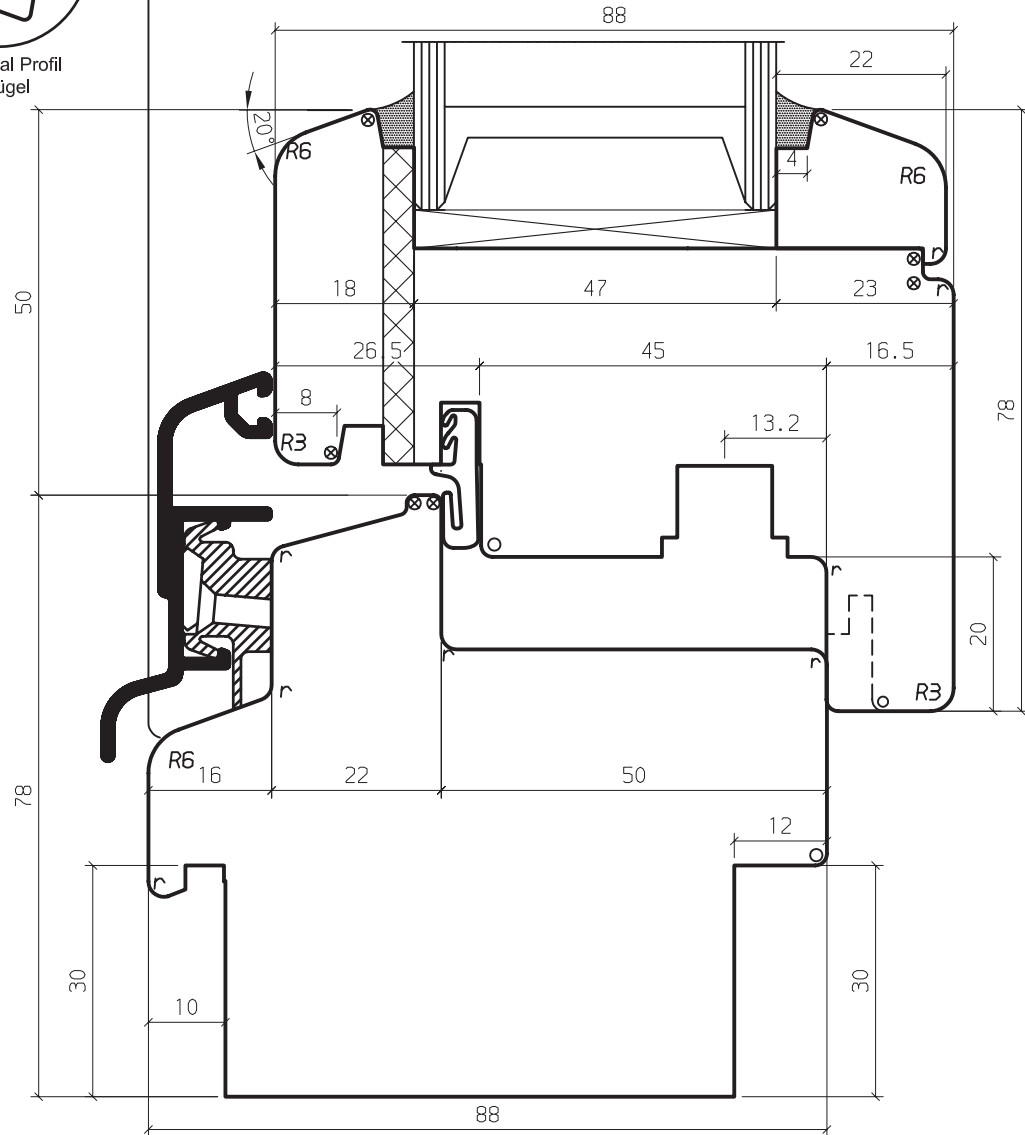

mittlere Überschlagdichtung

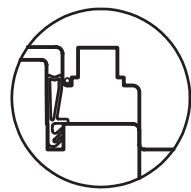

Rahmendichtung (20 mm) bei 12 mm Falzlufte

- ☒
- * = 0.5 mm
- = 0.5x45°
- X = 1 x45°
- = 1.5x45°
- ▽ = 2 x45°
- = R 0.5
- ⊗ = R 1
- = R 1.5
- r = R 2
- R = R 2.5

IV FENSTER 88
REGENSCHIENE: SPREE
ECKVERBINDUNG GEKONTERT



CAD

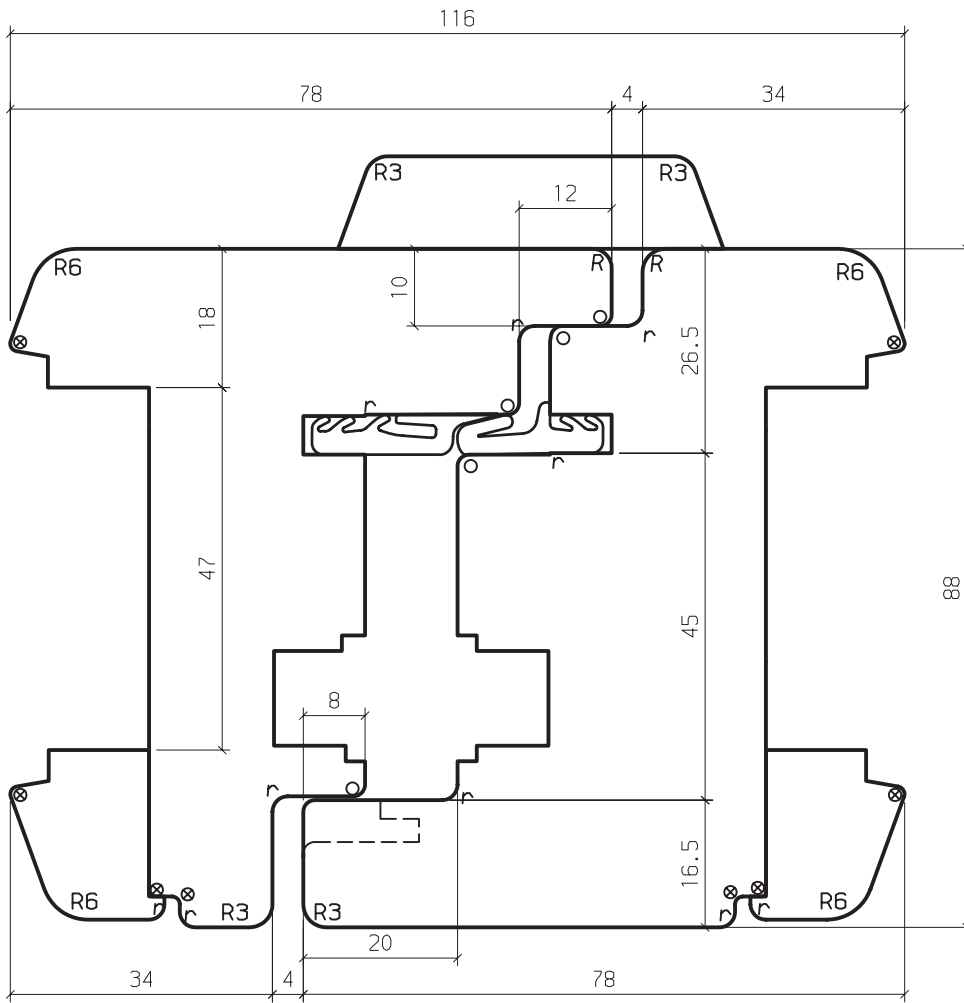

Maßstab	Gez.	05.11.09	DI
	1:1		
	Gepr.		
	%		
K-Name: ALBRECHT			
K-Nr.: . . .			

Ers. durch: . . . (B)
 Änderungen: (C) (D) (E) (F) (G)

IV FENSTER 88
 MITTELPARTIE
 INTEGRIERTE SCHLAGLEISTE



CAD

zusätzliche Optionen

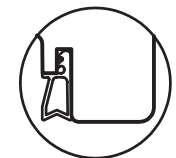

mittlere
 Überschlafdichtung

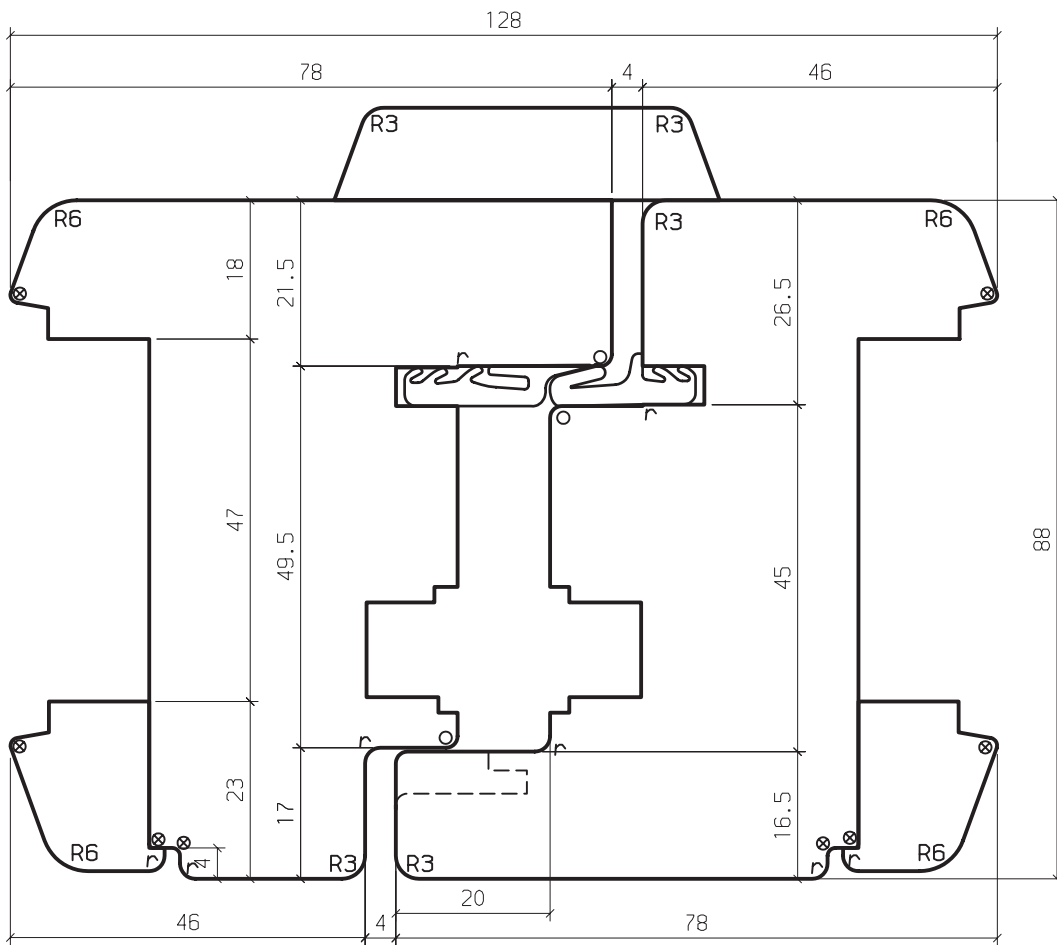

zusätzliche Optionen



mittlere
Überschlagdichtung

Maßstab	Gez.	05.11.09	DI
	1:1		
	Gepr.		
	✓		
K-Name: ALBRECHT			
K-Nr.: . . .			
Ers. durch:	(B)	Ers. für:	(A)
Aenderungen:		(D)	(F)
		(E)	(G)
IV FENSTER 88 MITTELPARTIE AUFGESETZTE SCHLAGLEISTE			
CAD			
			4 09 262 042 A

zusätzliche Optionen

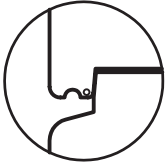

Offene Kopplung

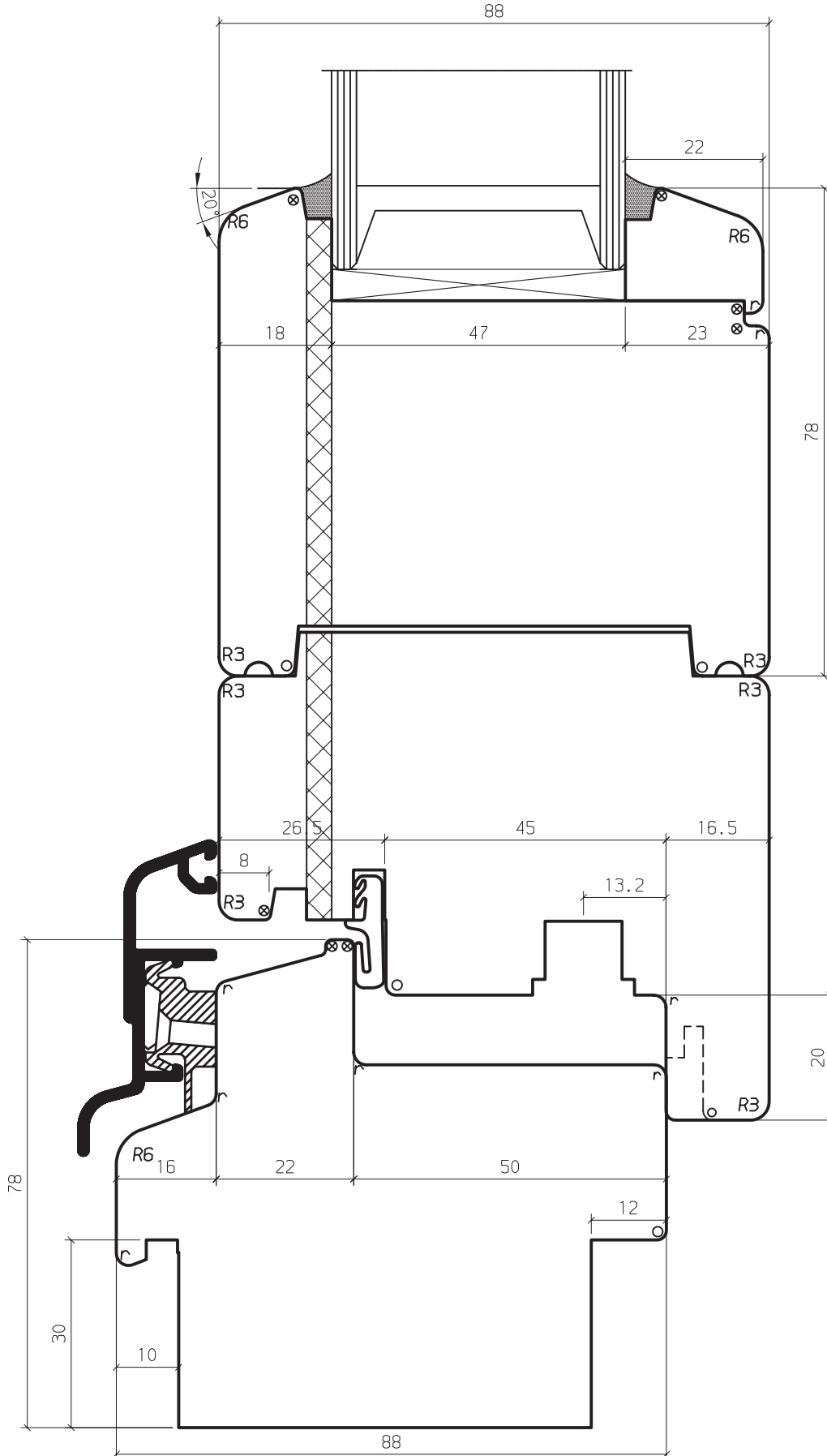

zusätzliche Optionen

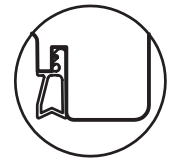

mittlere
Überschlagdichtung

Maßstab	Gez.	05.11.09	DI
	1:1		
K-Name	ALBRECHT		
	K-Nr.		
Ers. durch:	(B)	(D)	(F)
Aenderungen:	(C)	(E)	(G)
IV FENSTER 88 REGENSCHIENE: SPREE FLUEGELAUFDOPPLUNG			
			4 09 262 043 A

CAD

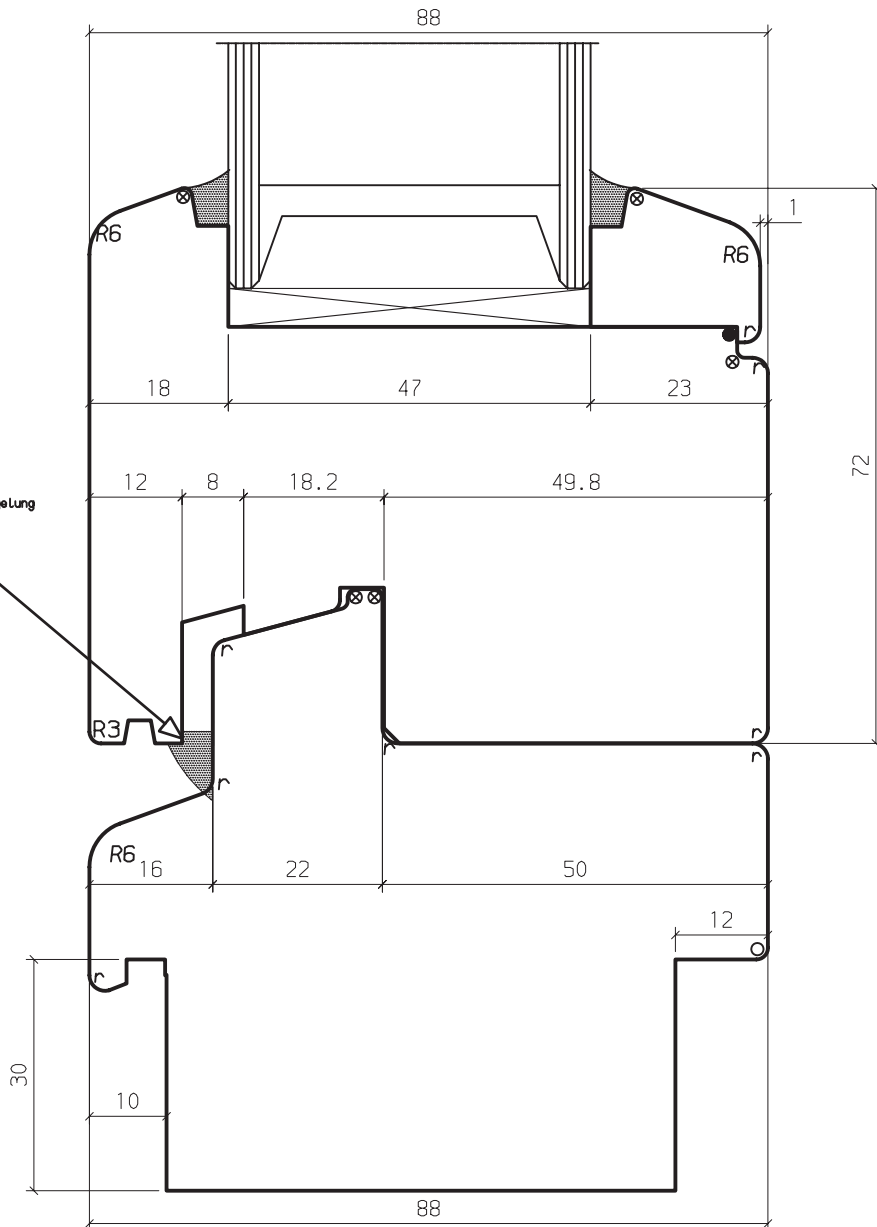
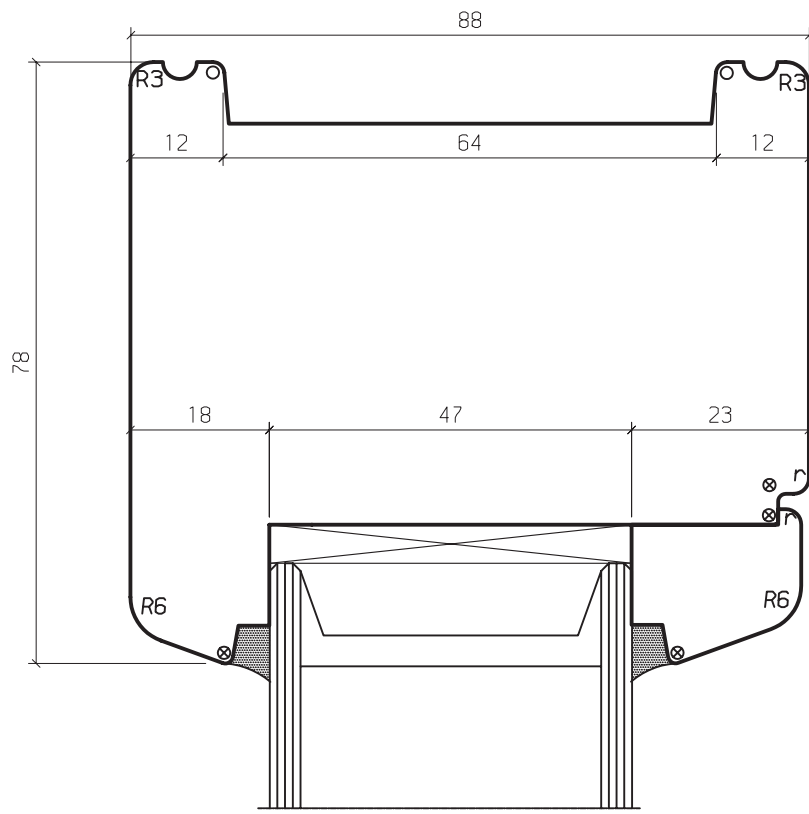

Maßstab	Gez.	05.11.09	DI
	1:1		
K-Name	ALBRECHT		
	K-Nr. 1		
IV FENSTER 88 FESTVERGLASUNG ECKVERBINDUNG: GEKONTERT			
4 09 262 044 A			



CAD

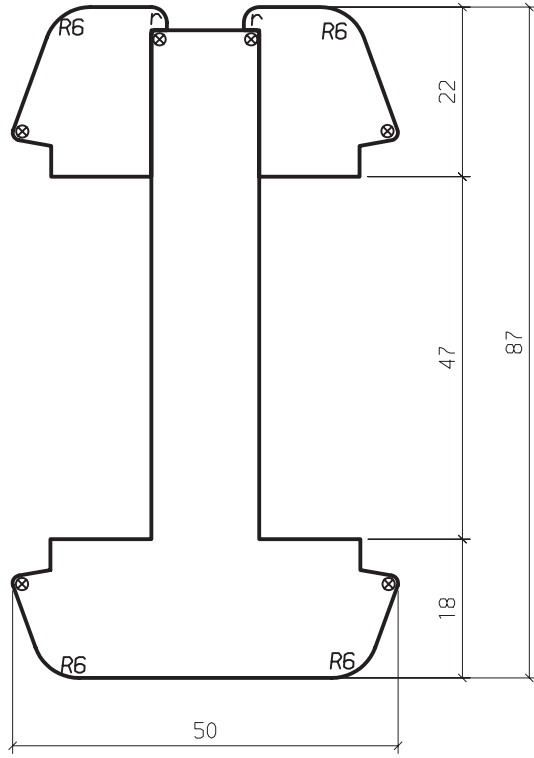
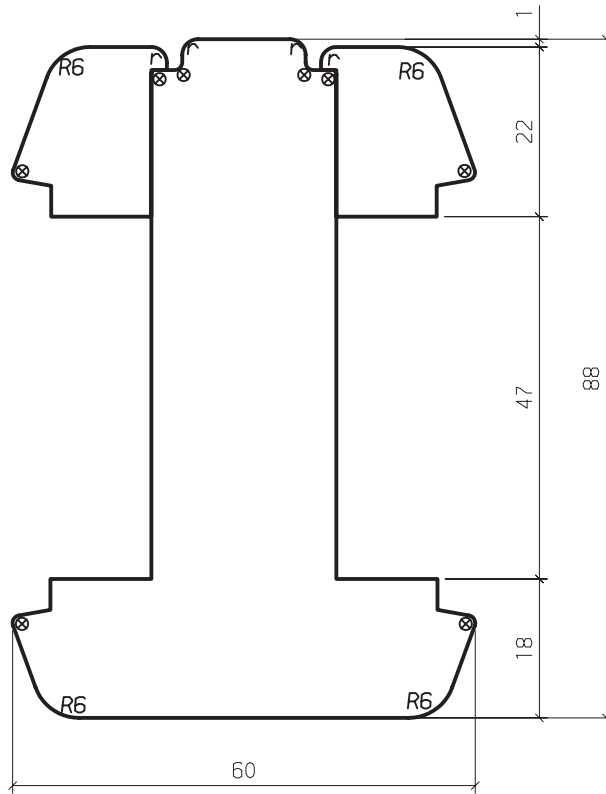

Ers. durch:	Ers. für:	Maßstab	Gez.	05.11.09	DI
			1:1	Gepr.	.
Aenderungen:	(B)	(D)	(F)		
	(C)	(E)	(G)		
			K-Name, ALBRECHT		
IV FENSTER 88 GLASTEILENDE SPROSSEN			K-Nr.: . . .		
			4 09 262 045 A		

CAD

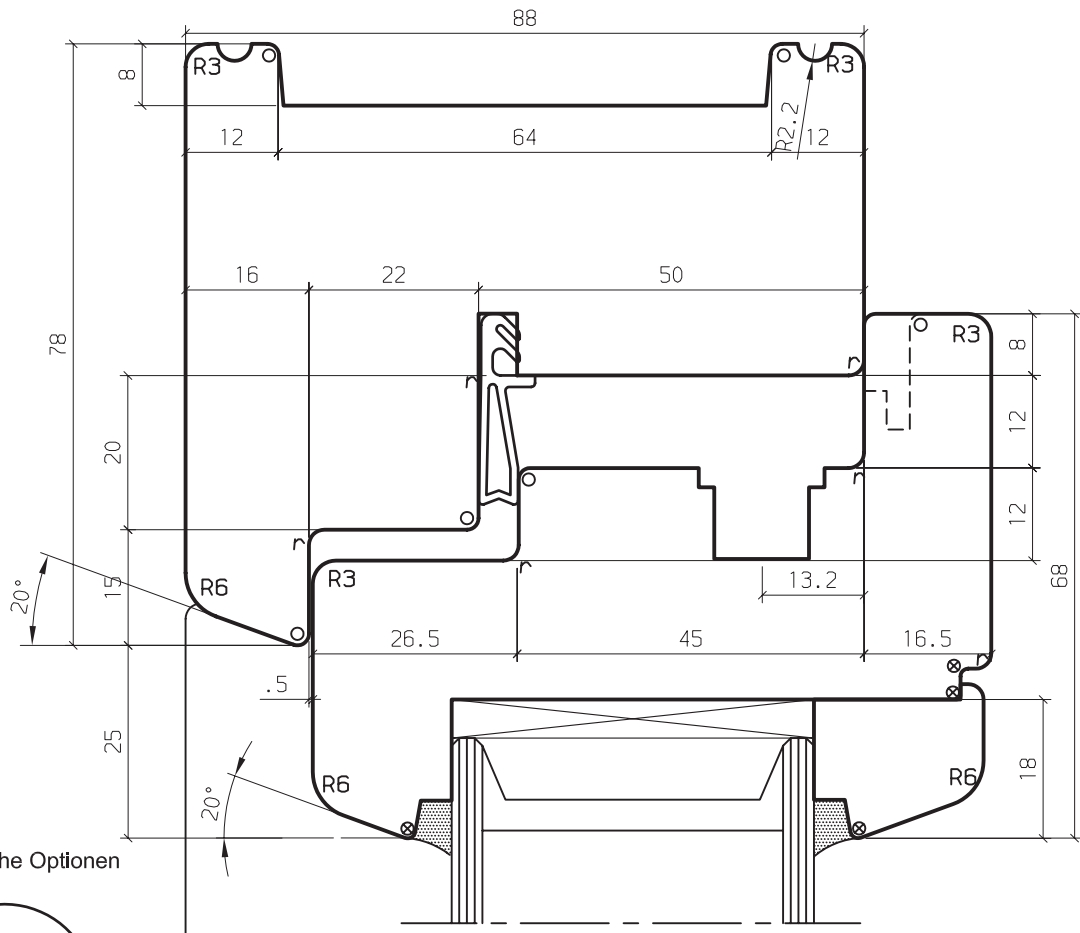

zusätzliche Optionen

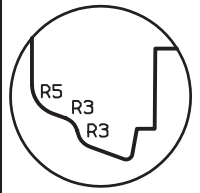

Rustikal Profil am Flügel

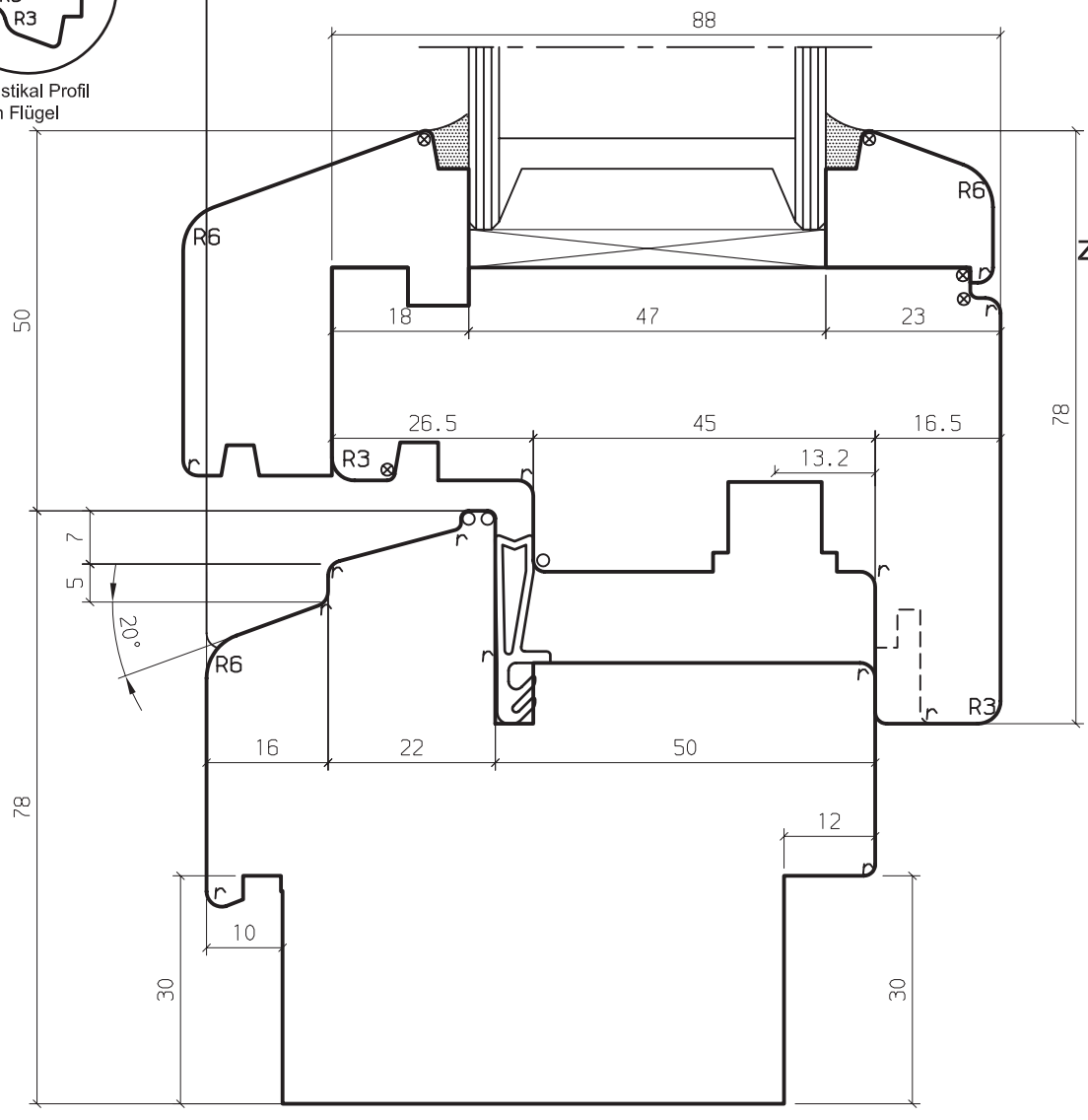

zusätzliche Optionen

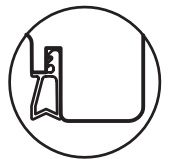

mittlere Überschlagdichtung

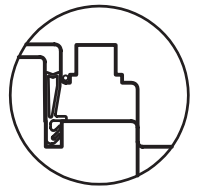

Rahmendichtung (20 mm) bei 12 mm Falzluf

Maßstab	Gez.	05.11.09	DI
	1:1	Gepr.	.
Ers. durch:	(B)	Ers. für:	(A)
	(C)	(D)	(F)
Änderungen:	(E)	(G)	(G)
	K-Name: ALBRECHT		
K-Nr.:			.
4 09 262 046			A

IV FENSTER 88
EINGEHÄNGTER WETTERSCHENKEL



CAD

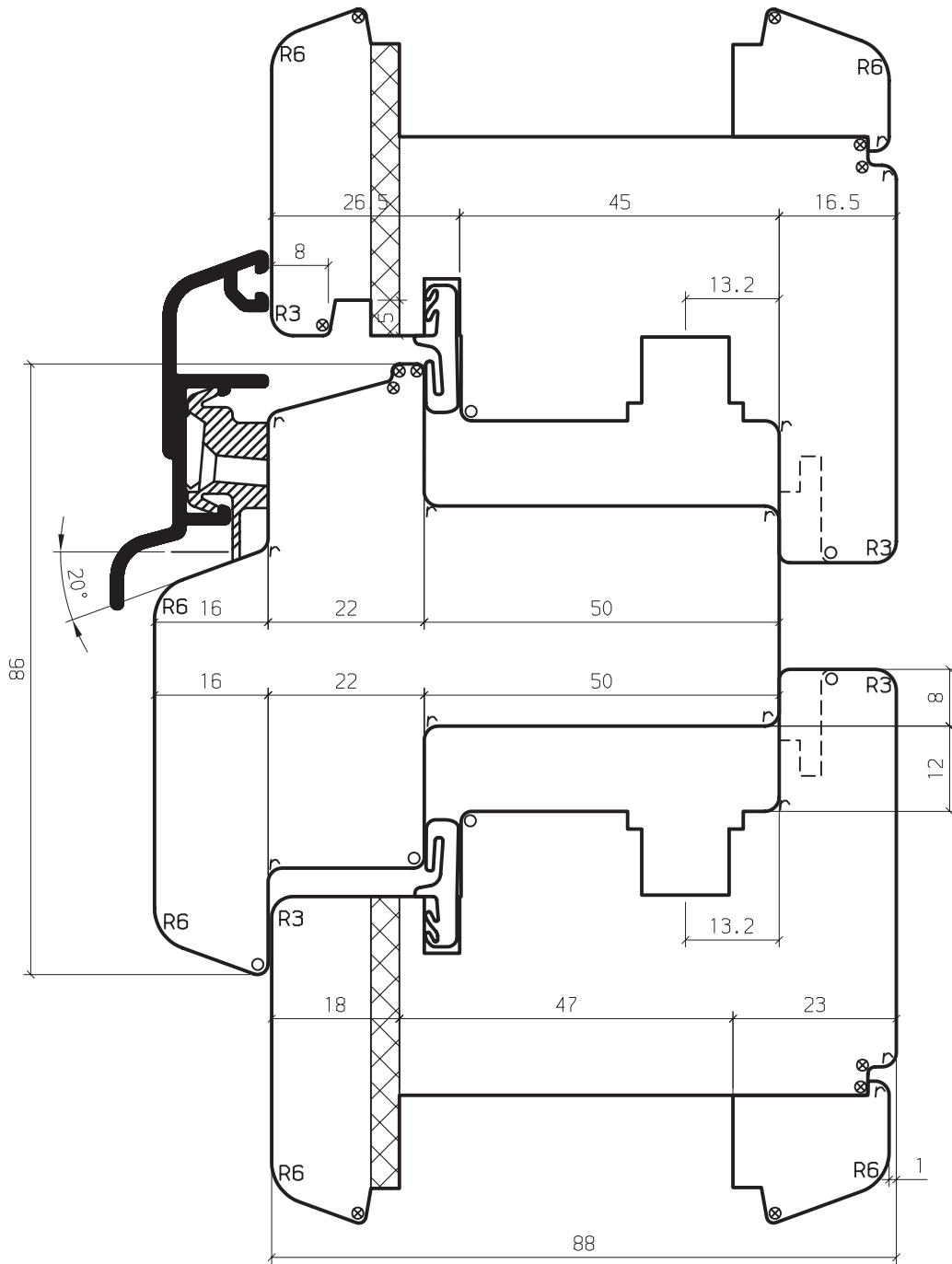

zusätzliche Optionen

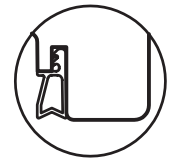

mittlere
Überschlagdichtung

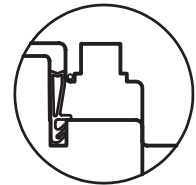

Rahmendichtung (20
mm) bei 12 mm
Falzlufte

Maßstab	Gez.	05.11.09	DI
	1:1		
K-Name	ALBRECHT		
	K-Nr.		
Ers. durch:	(B)	(D)	(F)
Aenderungen:	(C)	(E)	(G)
 IV FENSTER 88 KÄMPFER REGENSCHIENE: SPREE			
4 09 262 047		A	

CAD

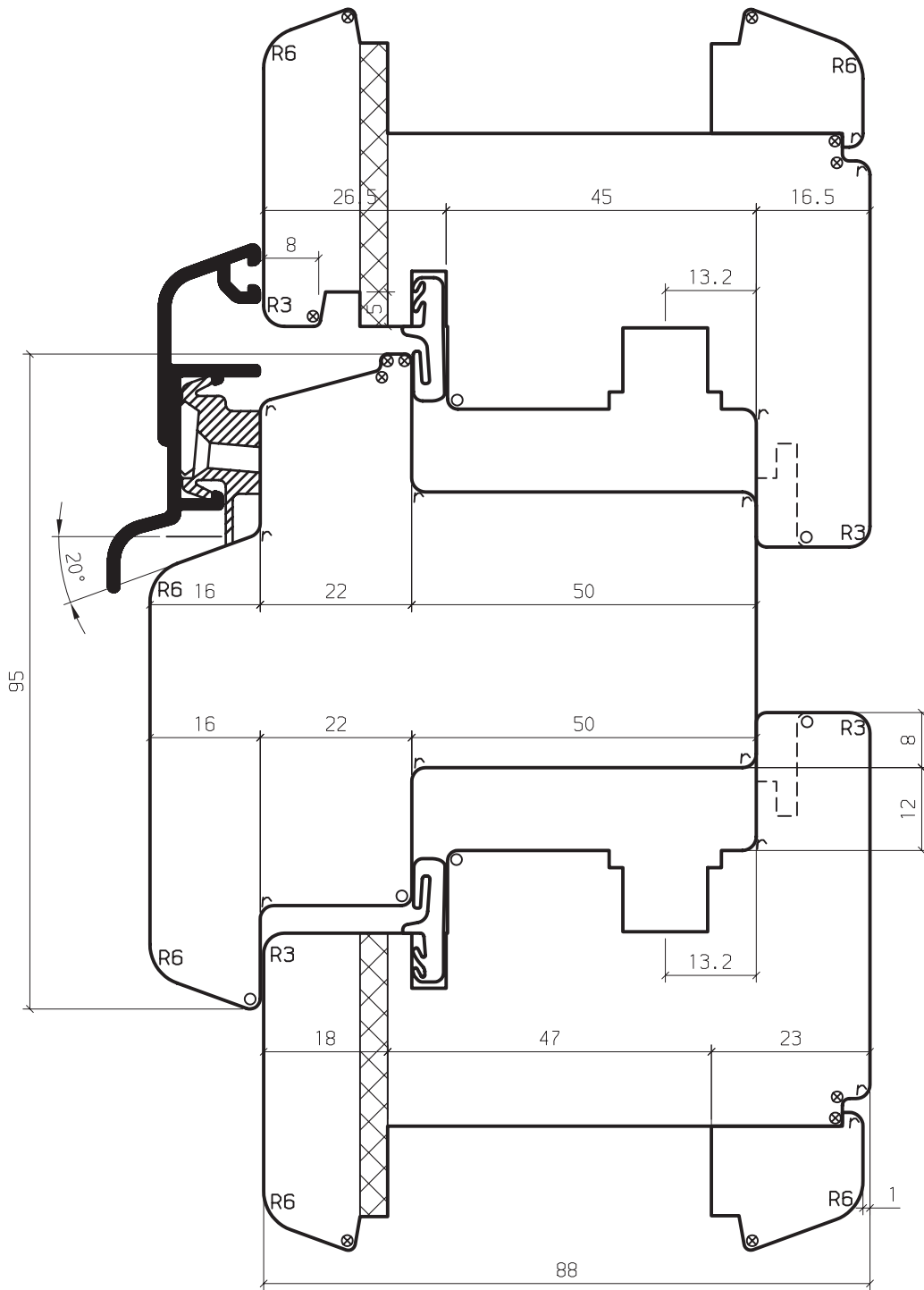

zusätzliche Optionen

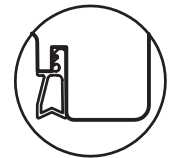

mittlere
Überschlagdichtung

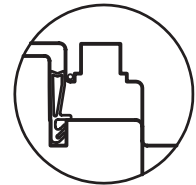

Rahmendichtung (20
mm) bei 12 mm
Falzlufte

Ers. durch:	Ers. für:	Maßstab	Gez.	05.11.09	DI
			1:1		
Änderungen:			Gepr.		
			%		
K-Name: ALBRECHT					
K-Nr.:					
IV FENSTER 88					
KÄMPFER					
REGENSCHIENE: SPREE					
CAD					
4 09 262 048 A					

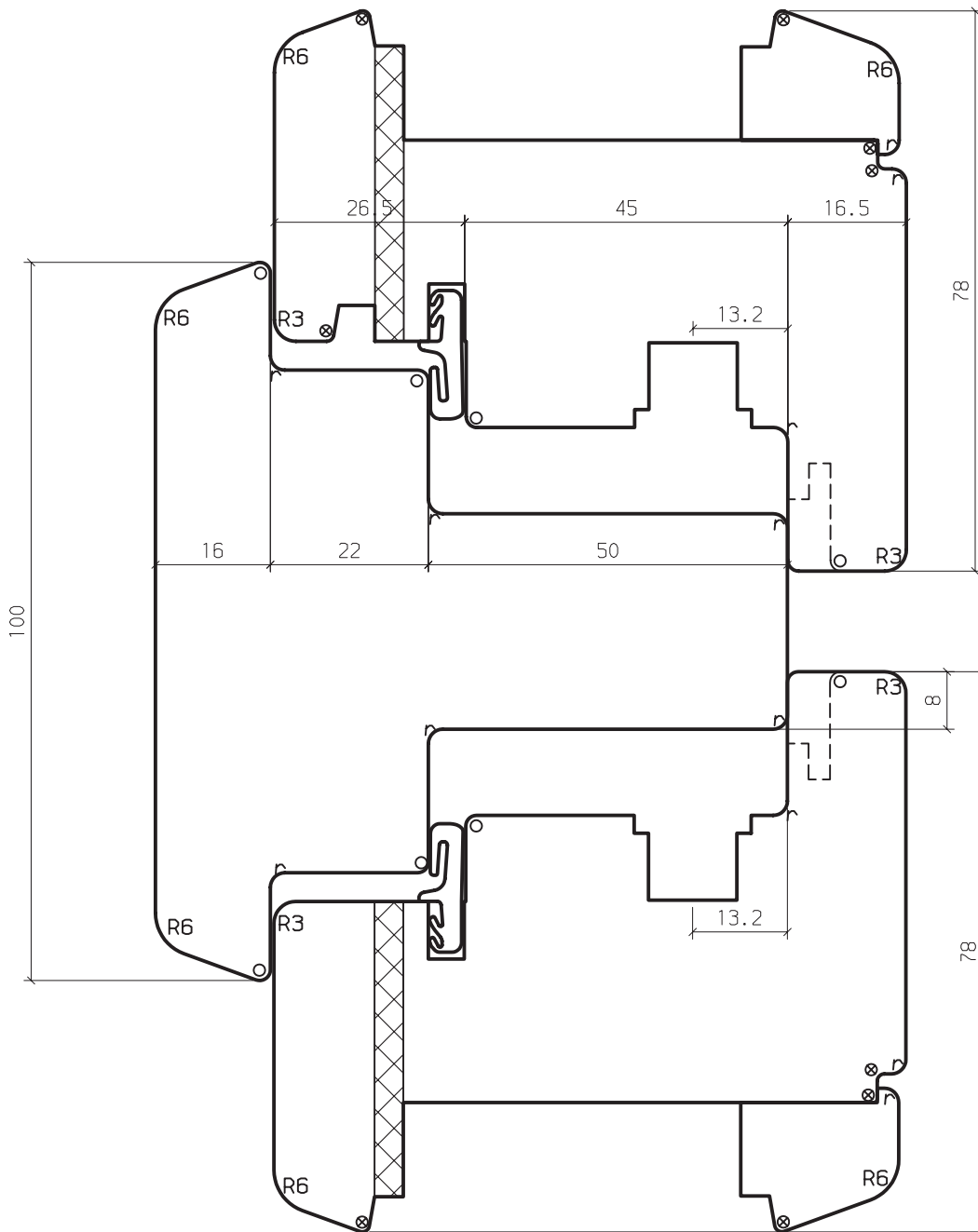

zusätzliche Optionen

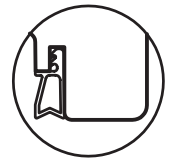

mittlere
Überschlagdichtung

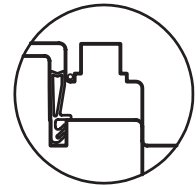

Rahmendichtung (20
mm) bei 12 mm
Falzluf

Ers. durch:	Ers. für:	Maßstab	Gez.	05.11.09	DI
		(B)	(D)	(F)	(G)
Aenderungen:	(C)	(E)	(F)	(G)	
		K-Name:	ALBRECHT		
		K-Nr.:	.		
		IV FENSTER 88 SETZHOLZ 2-FLG DK-DK		4 09 262 049 A	



CAD

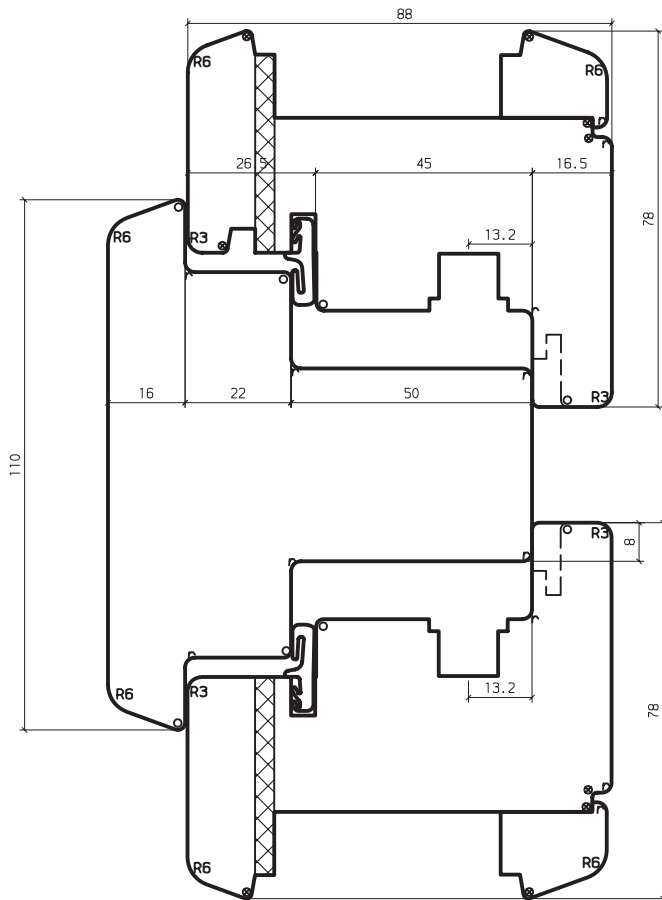
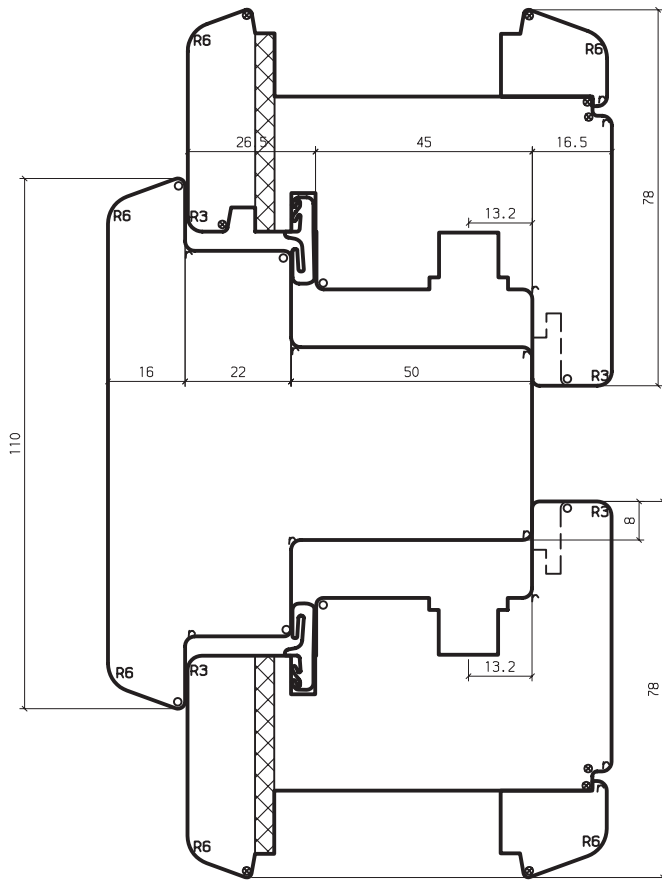

zusätzliche Optionen



mittlere
Überschlagdichtung

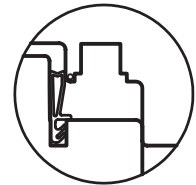

Rahmendichtung (20
mm) bei 12 mm
Falzlufte

Ers. durch:	(B)	Ers. für:	(A)	Maßstab	Gez.	05.11.09	DI
	(C)		(D)		(F)	1:1	
Aenderungen:		(E)	(G)	K-Nr.		ALBRECHT	
				K-Nr.		. . .	
 IV FENSTER 88 SETZHOLZ 3 FLG DK-DK-DK				4 09 262 050 A			

CAD

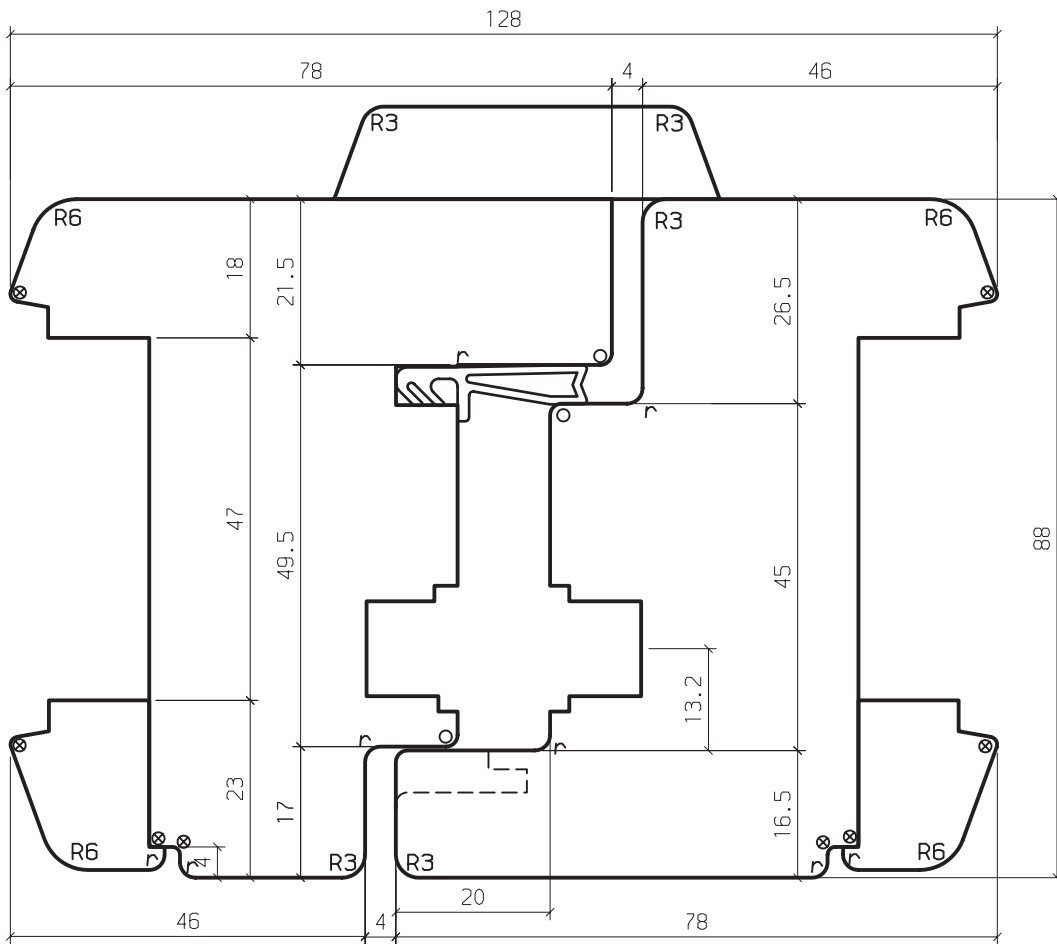

zusätzliche Optionen

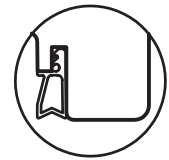

mittlere
Überschlagdichtung

CAD

IV FENSTER 68
MITTELPARTIE RAHMENDICHTUNG
AUFGESETZTE SCHLAGLEISTE

Ers. durch:	(B)	Ers. für:	(A)	Maßstab	Gez.	05.11.09	DI
Aenderungen:	(C)	(D)	(F)	1:1	Gepr.	.	.
	(E)	(G)		∞			
©ERTLI				K-Name: ALBRECHT			
				K-Nr.: . . .			
				4 09 262 051 A			

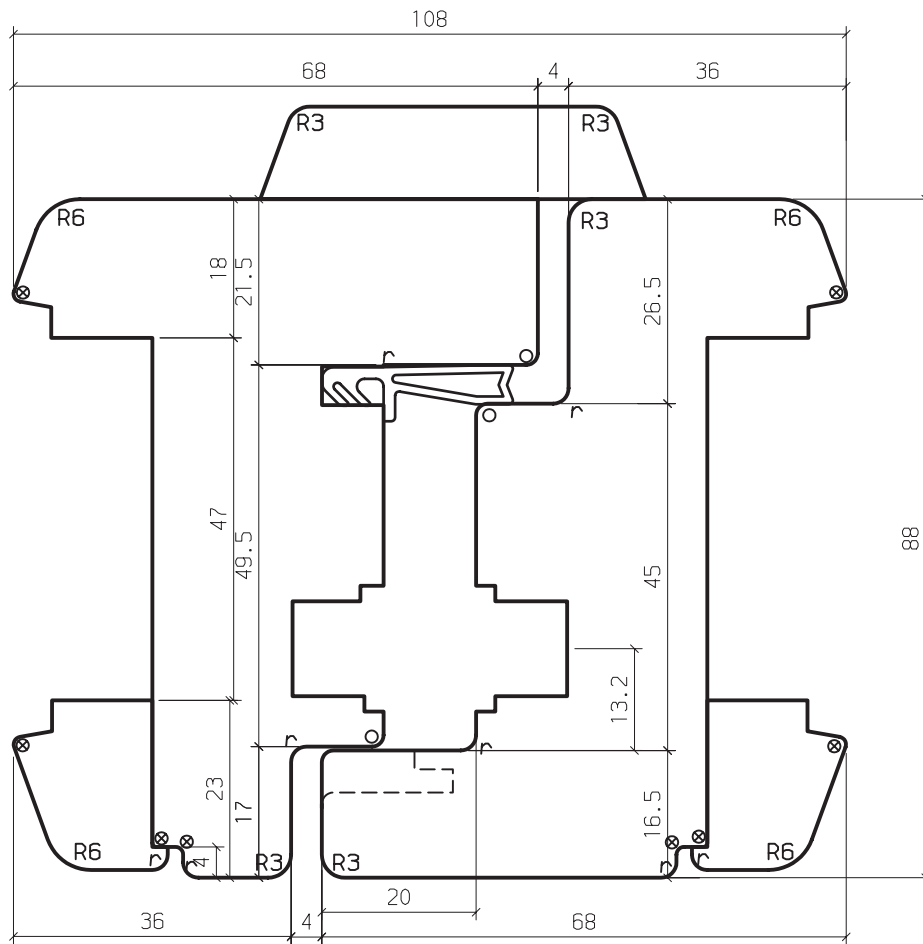

zusätzliche Optionen

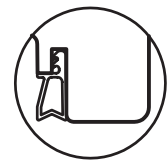

mittlere
Überschlagdichtung

CAD

Ers. durch:	(B)	Ers. für:	(A)	Maßstab	Gez.	05.11.09	DI
				Aenderungen:	(D)	(F)	1:1
	(C)	(E)	(G)		%		
 IV FENSTER 68 MITTELPARTIE RAHMENDICHTUNG AUFGESETZTE SCHLAGLEISTE				K-Name: ALBRECHT			
				K-Nr.: . . .			
				4 09 262 052 A			

- ☒ = Schleifzugabe
- * = 0.5 mm
- = 0.5x45°
- X = 1 x45°
- = 1.5x45°
- ▽ = 2 x45°
- = R 0.5
- ⊙ = R 1
- = R 1.5
- = R 2
- R = R 2.5

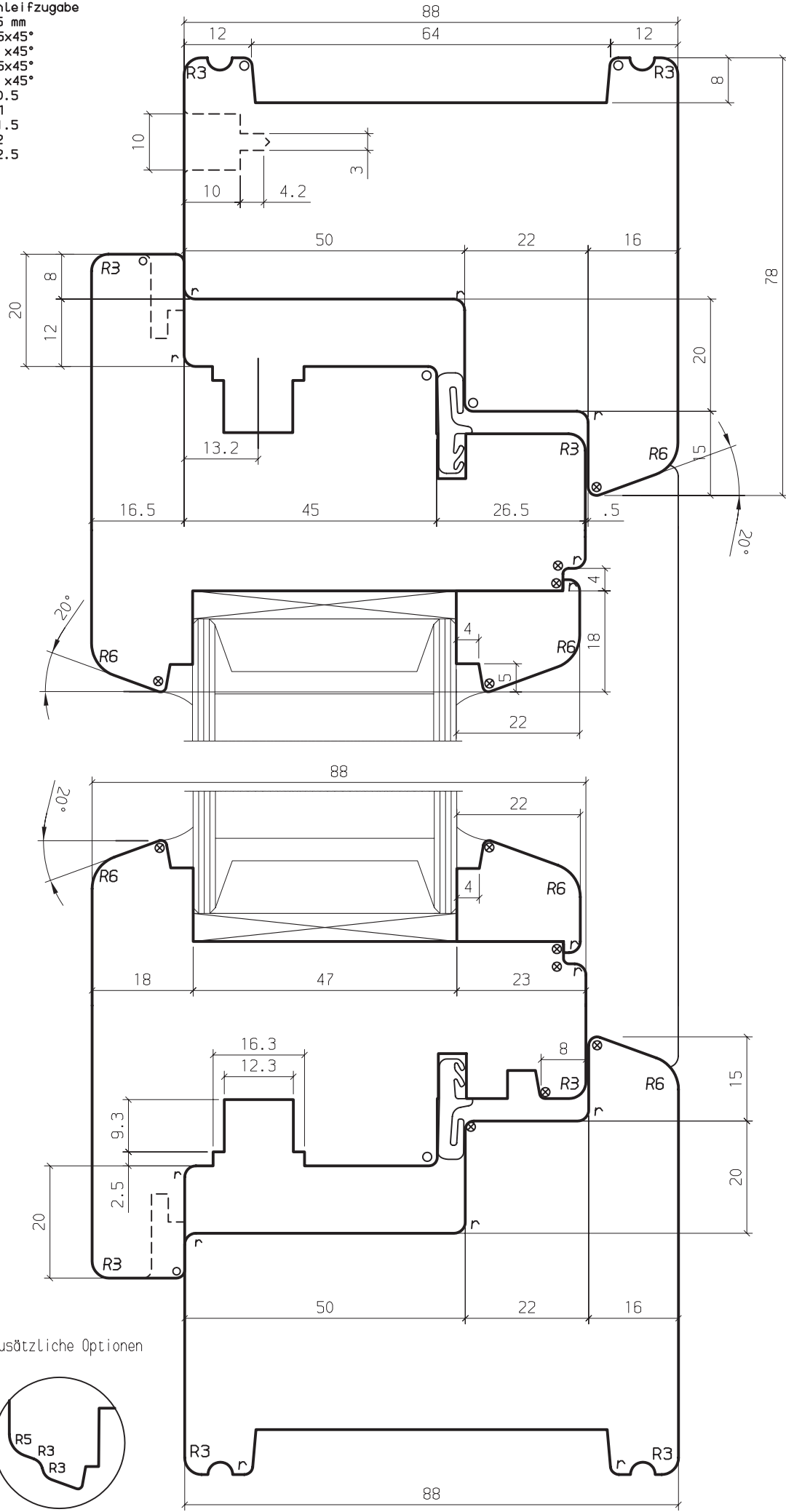

zusätzliche Optionen

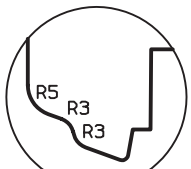

Rustikal Profil
am Flügel

Maßstab	Gez.	05.11.09	DI
	1:1		
K-Name: ALBRECHT	Gepr.		
	✓		
K-Nr.:			

Ers. durch:	(B)	Ers. für:	(A)
Aenderungen:	(C)	(D)	(F)
	(E)	(G)	(G)

IV FENSTER 88

NACH AUSSEN ÖFFNEND



CAD

4 09 262 053 A