

Maßstab	Gez.	05.11.09	DI
	1:1	Gepr.	.
K-Name	ALBRECHT		
	K-Nr. 1		
Ers. durch:	(B)	(D)	(E)
Ers. für:	(A)	(F)	(G)
Aenderungen:	(C)	(G)	
<b>IV FENSTER 68</b> <b>REGENSCHIENE: SPREE</b> <b>ECKVERBINDUNG GEKONTERT</b>			
			
<b>4 09 262 000 A</b>			

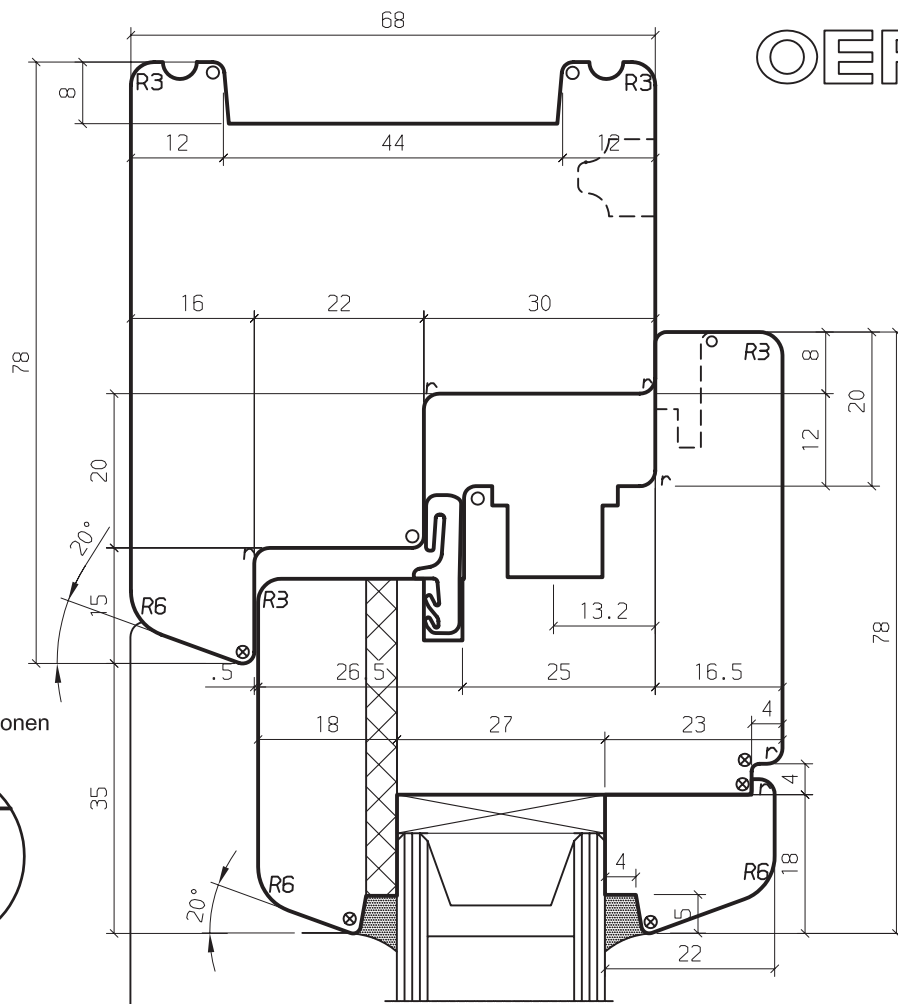

zusätzliche Optionen

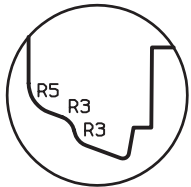

Rustikal Profil  
am Flügel

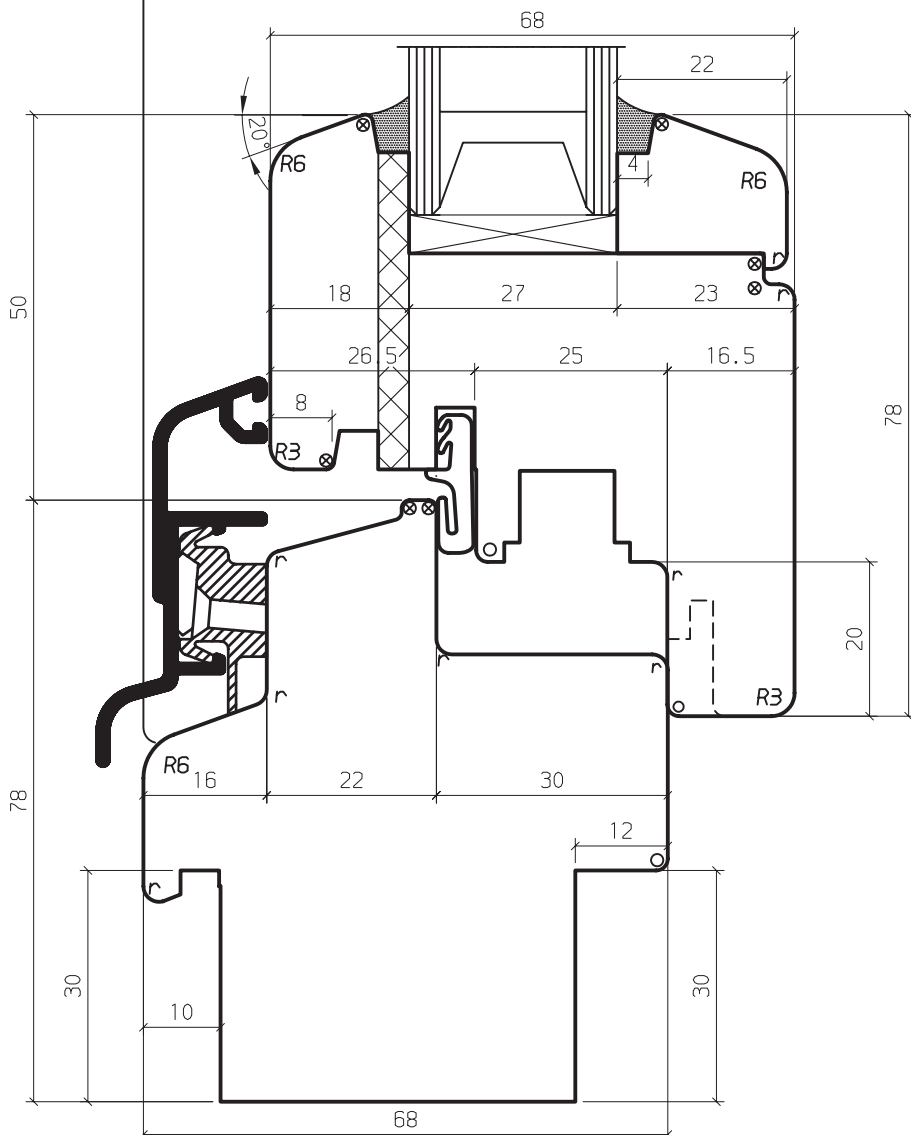

zusätzliche Optionen

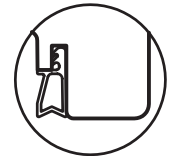

mittlere  
Überschlagdichtung

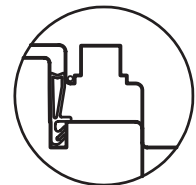

Rahmendichtung (20  
mm) bei 12 mm  
Falzlufte

- ☒
- \* = 0.5 mm
- = 0.5x45°
- X = 1 x45°
- = 1.5x45°
- ▽ = 2 x45°
- = R 0.5
- ⊗ = R 1
- = R 1.5
- r = R 2
- R = R 2.5

CAD

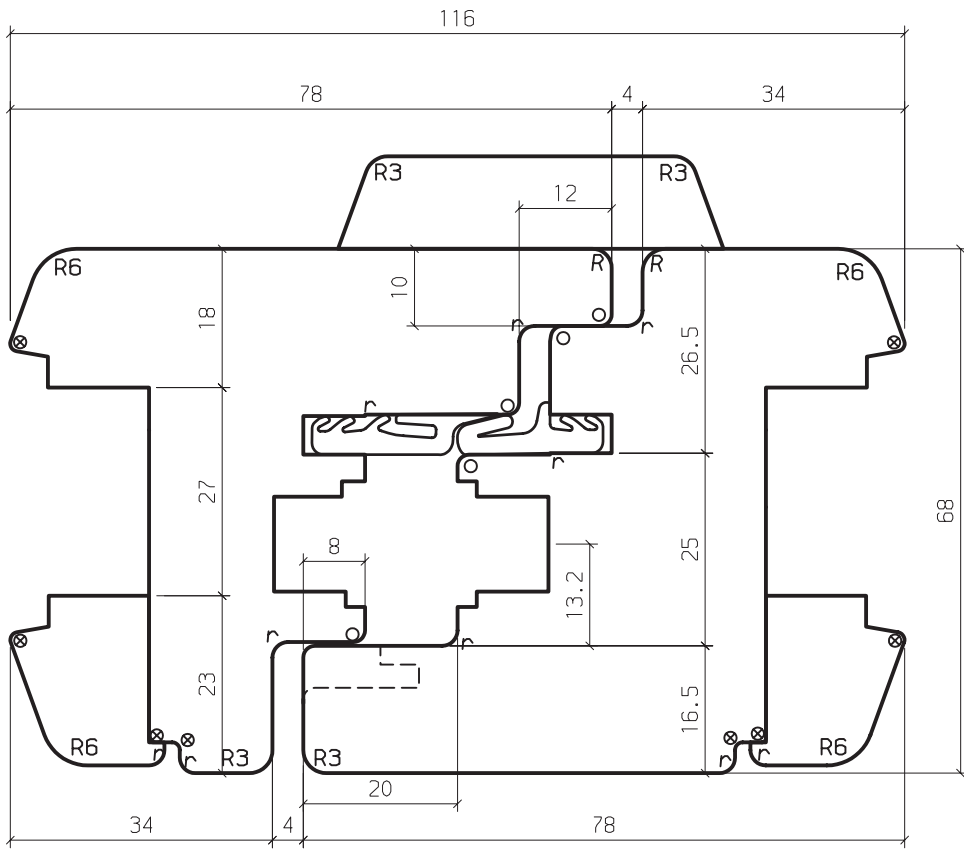

Maßstab	Gez.	05.11.09	DI
	1:1		
	Gepr.		
	✓		
K-Name: ALBRECHT			
K-Nr.: . . .			

Ers. durch: . . . (B)  
 Aenderungen: (C) (D) (E) (F) (G)

**IV FENSTER 68**  
**MITTELPARTIE**  
**INTEGRIERTE SCHLAGLEISTE**



CAD

zusätzliche Optionen

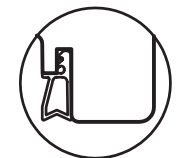

mittlere  
 Überschlafdichtung

4 09 262 001 A

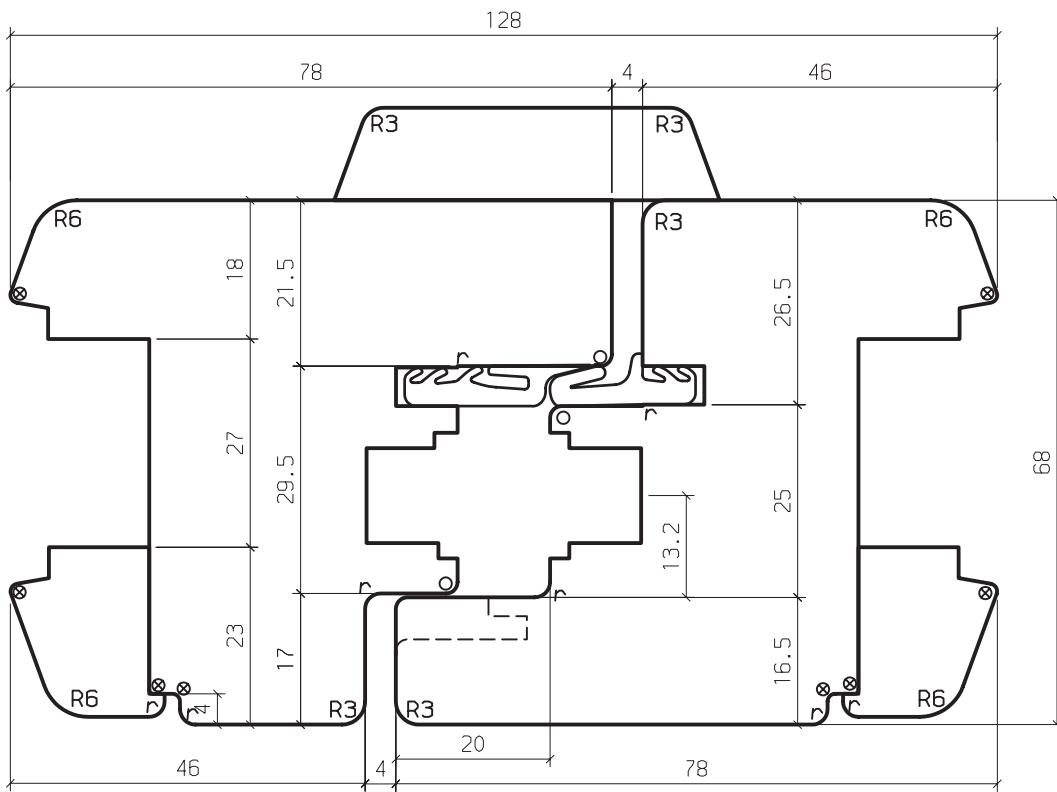

zusätzliche Optionen

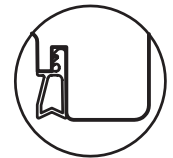

mittlere  
Überschlagdichtung

Ers. durch:	Ers. für:	Maßstab	Gez.	05.11.09	DI
			1:1	Gepr.	.
Aenderungen:	(D)	(F)	1:1	Gepr.	.
	(E)	(G)	1:1	Gepr.	.
©EERTLI			K-Name, ALBRECHT		
IV FENSTER 68			K-Nr. 1 . .		
MITTELPARTIE			4 09 262 002 A		
AUFGESETZTE SCHLAGLEISTE					

CAD

zusätzliche Optionen

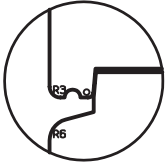

Offene Kopplung

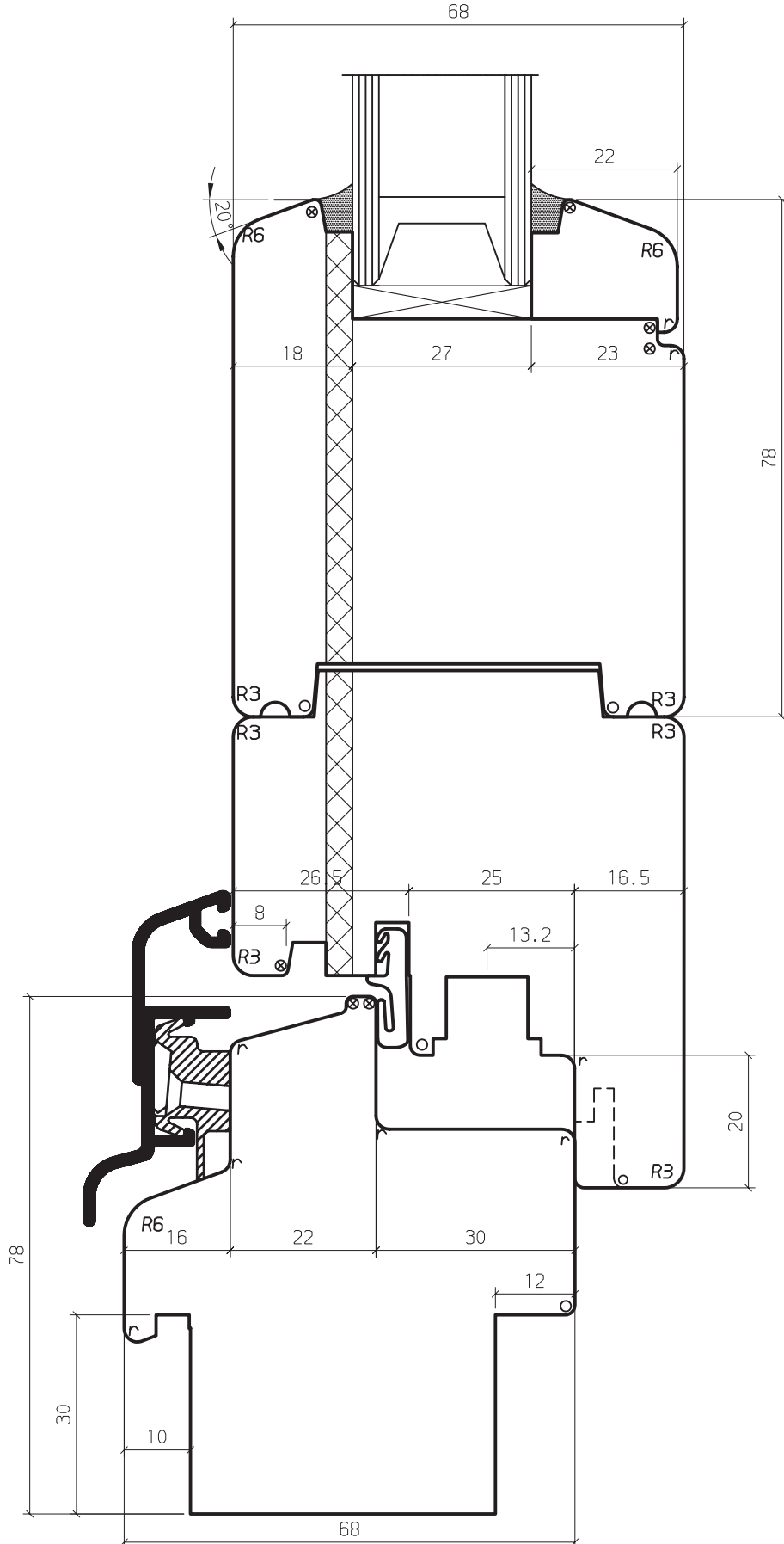

zusätzliche Optionen

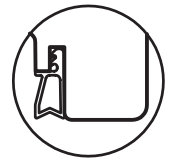

mittlere  
Überschlafdichtung

Maßstab	Gez.	05.11.09	DI
	1:1		
	Gepr.		
	%		
Ers. durch:	Ers. für:	(A)	(F)
(B)	(D)	(E)	(G)
Änderungen:			
IV FENSTER 68 REGENSCHIENE: SPREE FLUEGELAUFDOPPLUNG			
OERTLI 			
K-Name: ALBRECHT			
K-Nr.: . . .			
4 09 262 003			A

CAD

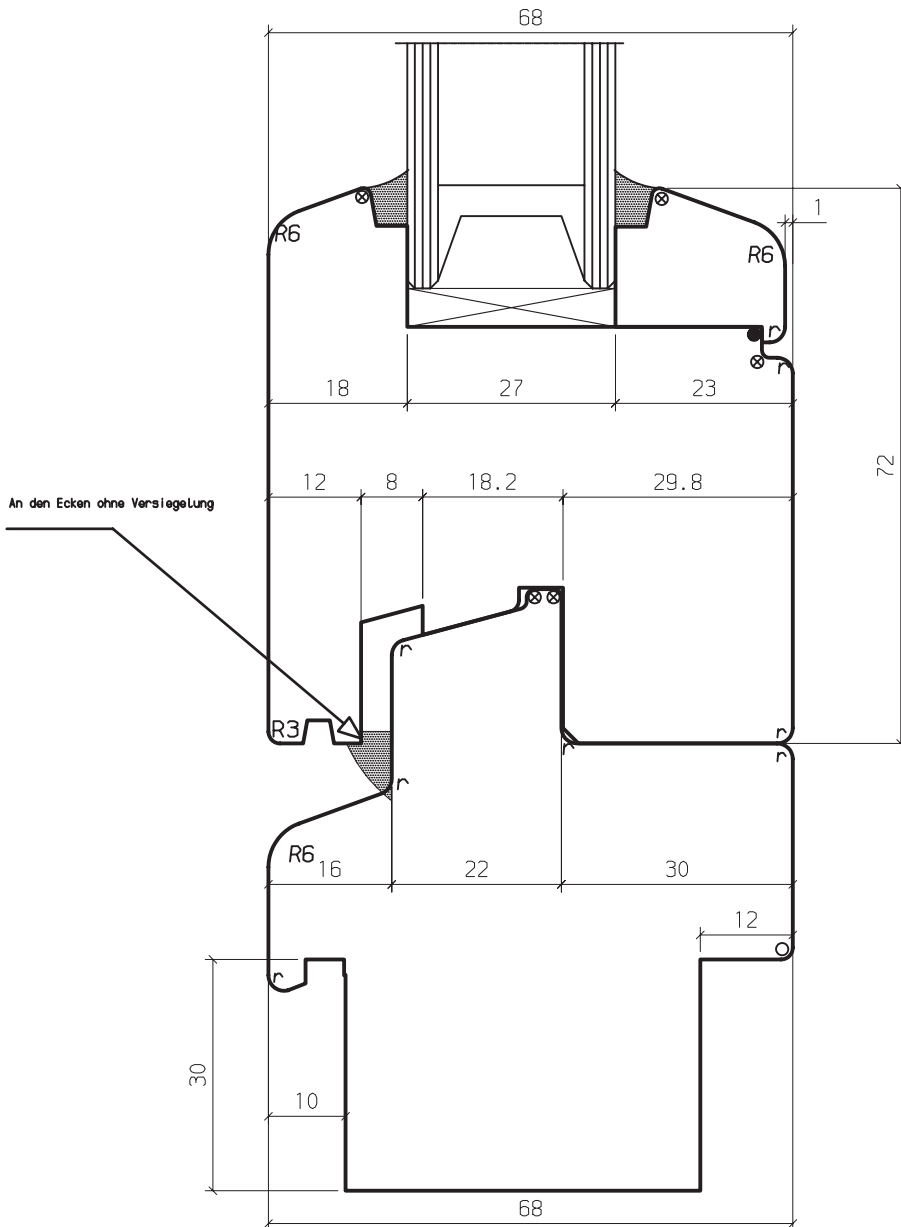
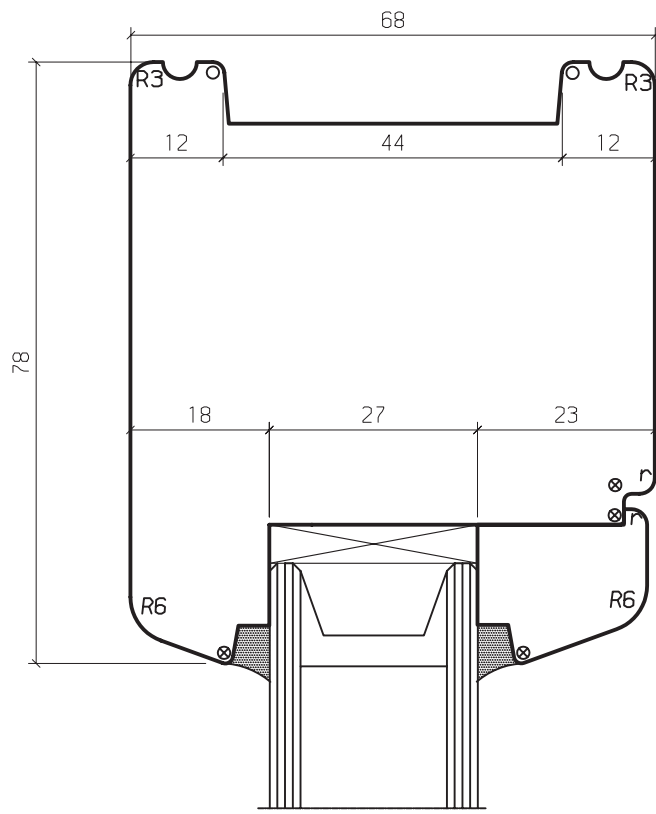

Maßstab	Gez.	05.11.09	DI
	1:1		
K-Nr.	Gepr.		
	1:1		
K-Name: ALBRECHT			
K-Nr.: . . .			
<b>IV FENSTER 68 FESTVERGLASUNG ECKVERBINDUNG: GEKONTERT</b>			
<b>4 09 262 004 A</b>			



CAD

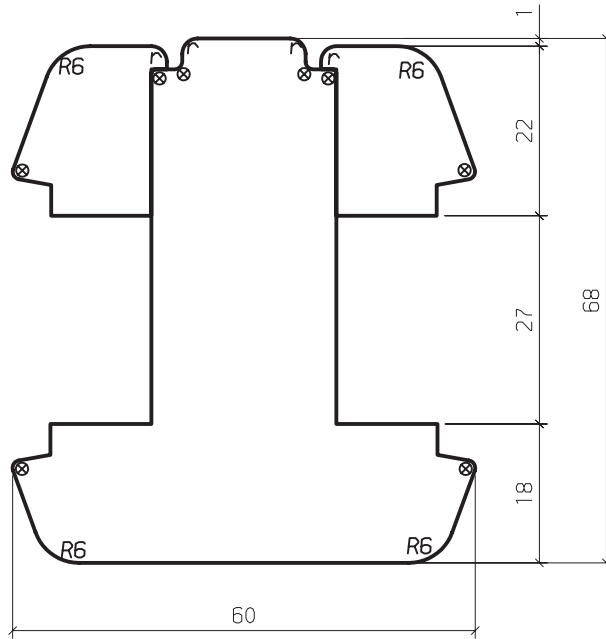
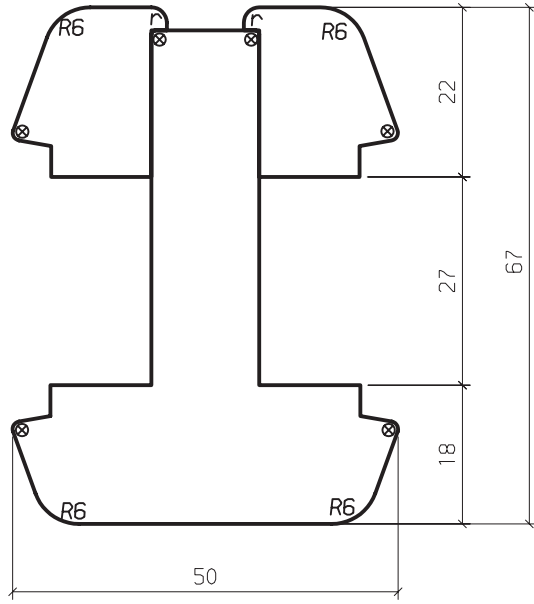

Ers. durch:	Ers. für:	(A)	(B)	(D)	(E)	(F)	(G)	Maßstab	Gez.	05.11.09	DI
									1:1	Gepr.	.
Aenderungen:	(C)							1:1	Gepr.	.	.
								1:1	Gepr.	.	.
 <b>IV FENSTER 68</b> <b>GLASTEILENDE SPROSSEN</b>									K-Name: ALBRECHT		
									K-Nr.: . . .		
									4 09 262 005 A		

CAD

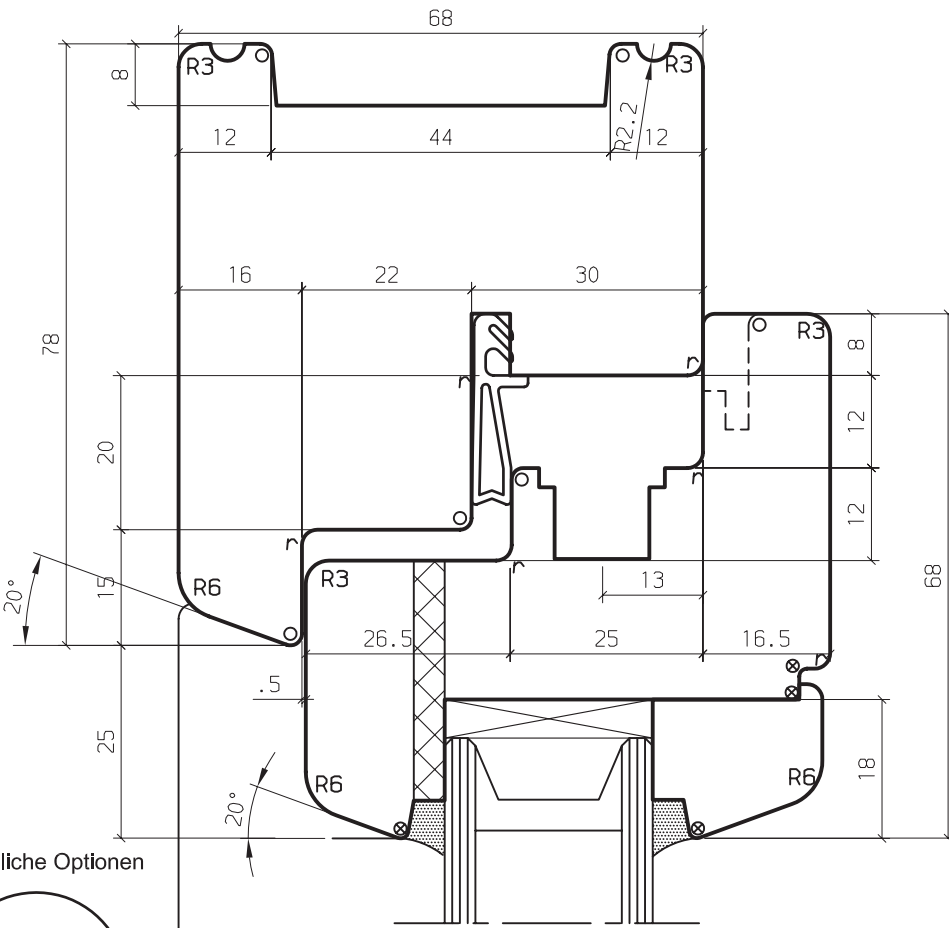

zusätzliche Optionen

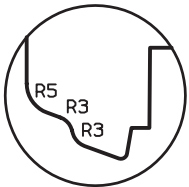

Rustikal Profil  
am Flügel

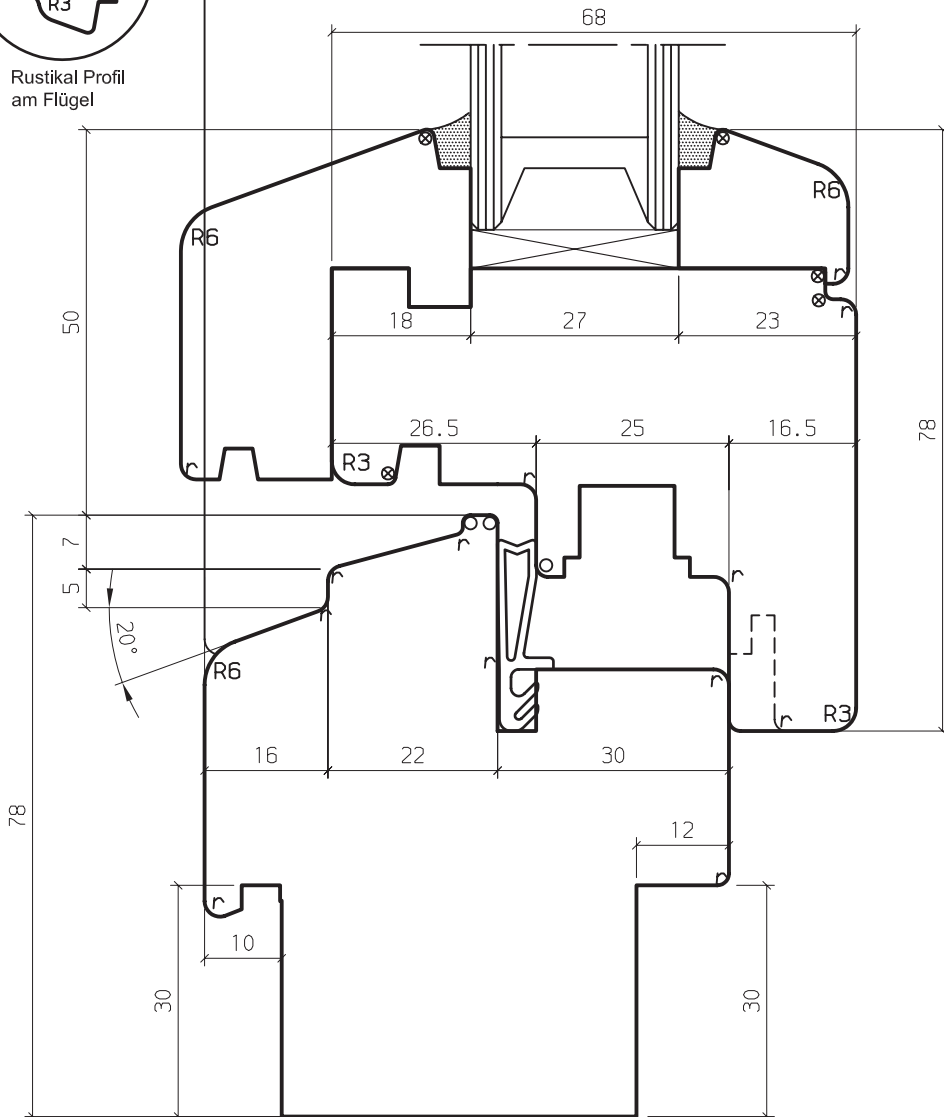

zusätzliche Optionen



mittlere  
Überschlagdichtung

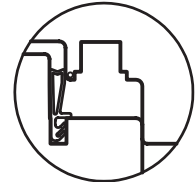

Rahmendichtung (20  
mm) bei 12 mm  
Falzluf

Ers. durch:	(B)	Ers. für:	(A)	Maßstab	Gez.	05.11.09	DI
	(C)	(D)	(E)	1:1	Gepr.	.	.
Aenderungen:	(F)	(G)		x			
K-Name: ALBRECHT							
K-Nr.: . . .							
<b>IV FENSTER 68 EINGEHÄNGTER WETTERSCHENKEL</b>							
							
CAD							
<b>4 09 262 006 A</b>							

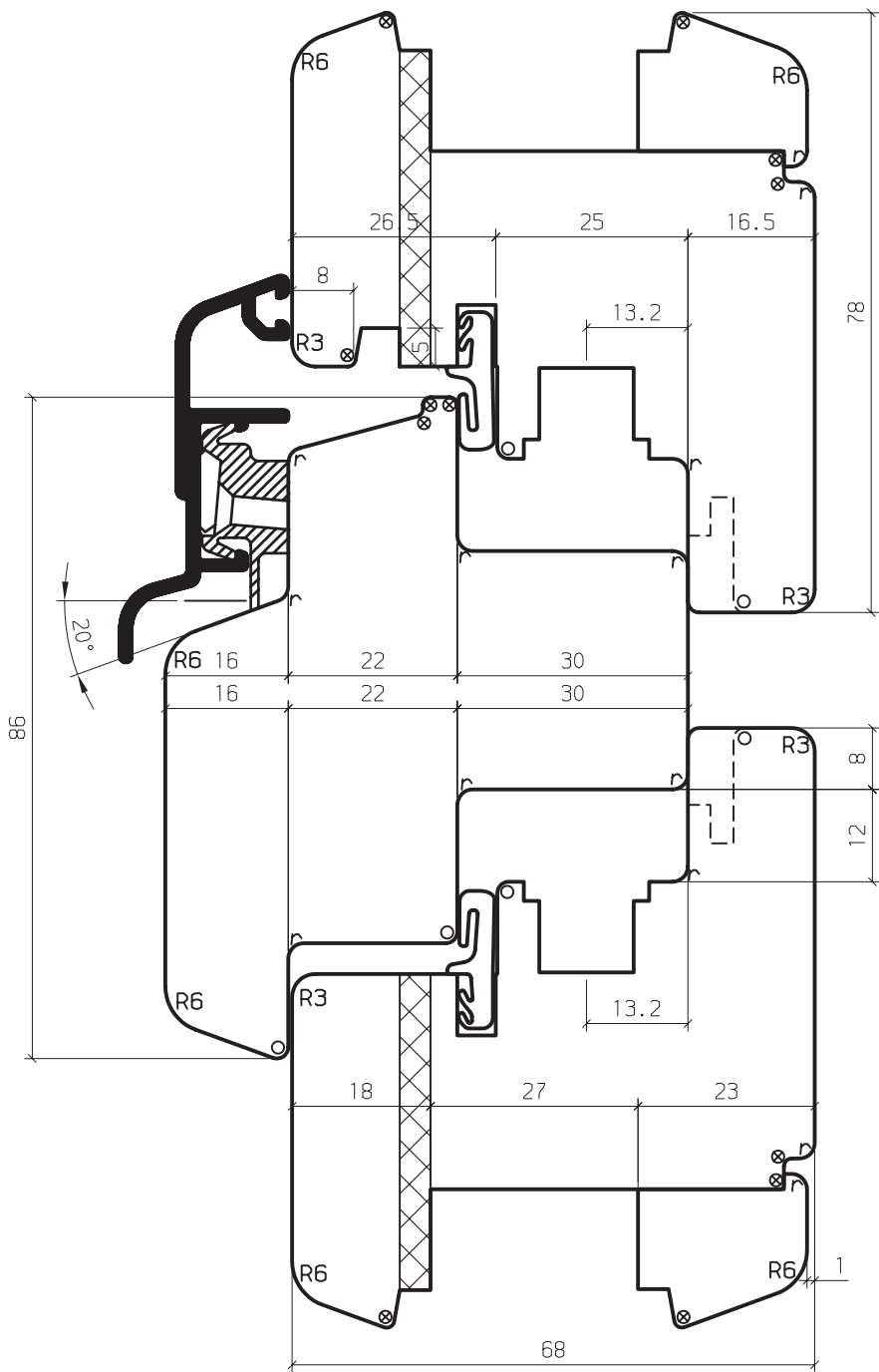

zusätzliche Optionen

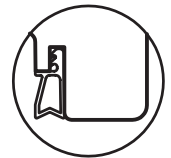

mittlere  
Überschlagdichtung

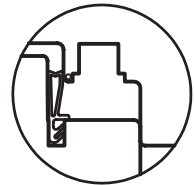

Rahmendichtung (20  
mm) bei 12 mm  
Falzluf

Ers. durch:	Ers. für:	Maßstab	Gez.	05.11.09	DI
		(B)	(D)	(A)	(F)
Änderungen:	(C)	1:1	Gepr.	.	.
		(E)	%	.	.
		K-Name: ALBRECHT			
<b>IV FENSTER 68</b> <b>KÄMPFER</b> <b>REGENSCHIENE: SPREE</b>		K-Nr.: . . .			
		4 09 262 007 A			

CAD



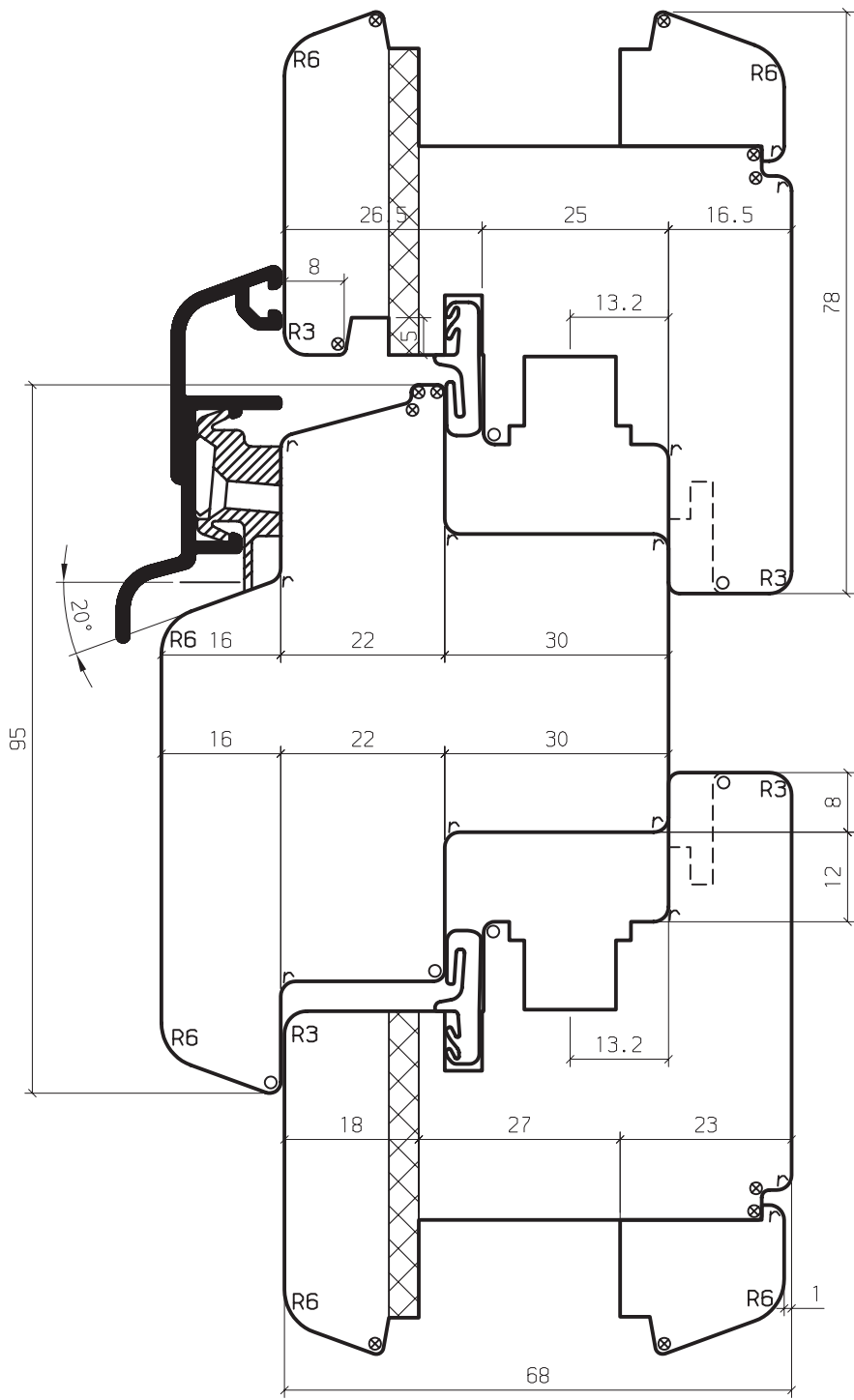

zusätzliche Optionen

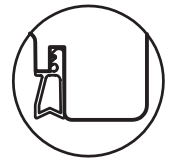

mittlere  
Überschlagdichtung

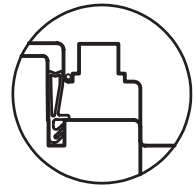

Rahmendichtung (20  
mm) bei 12 mm  
Falzluf

Ers. durch:	Ers. für:	Maßstab	Gez.	05.11.09	DI
			1:1		
Änderungen:			Gepr.		
			%		
K-Name: ALBRECHT					
K-Nr.: . . .					
IV FENSTER 68					
KÄMPFER					
REGENSCHIENE: SPREE					
CAD					
			4 09 262 008 A		

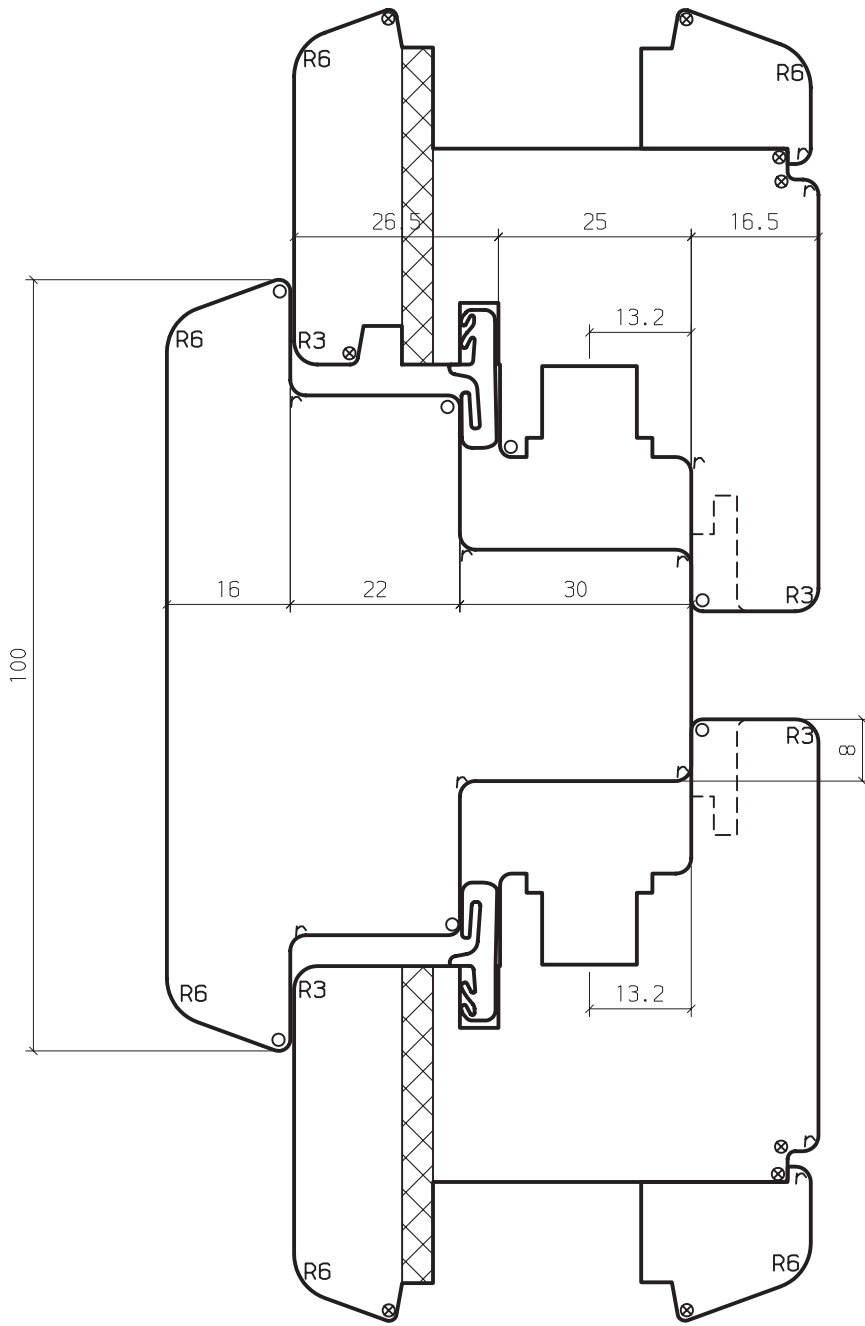

zusätzliche Optionen

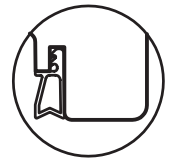

mittlere  
Überschlagdichtung

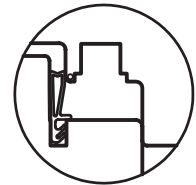

Rahmendichtung (20  
mm) bei 12 mm  
Falzlufte

CAD

Ers. durch:	Ers. für:	Maßstab	Gez.	05.11.09	DI
			1:1		
Änderungen:			Gepr.		
			%		
K-Name: ALBRECHT					
K-Nr.: . . .					
IV FENSTER 68					
SETZHOLZ					
2-FLG DK-DK					
4 09 262 009 A					

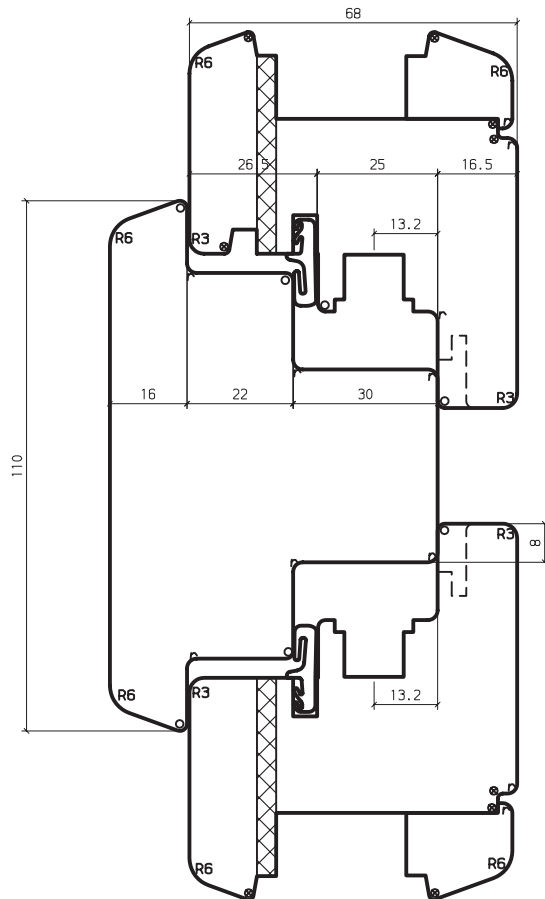
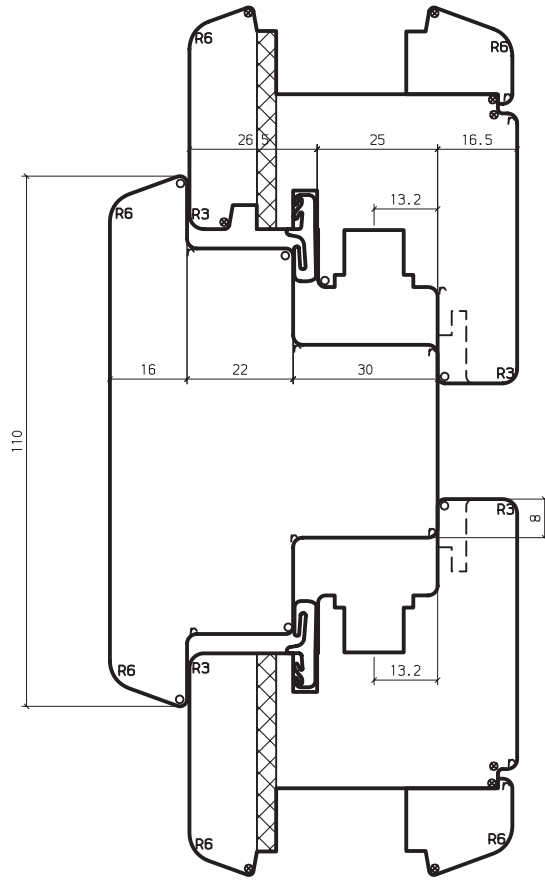

zusätzliche Optionen



mittlere  
Überschlagdichtung

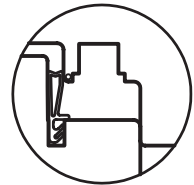

Rahmendichtung (20  
mm) bei 12 mm  
Falzlufte

Ers. durch:	(B)	Ers. für:	(A)	Maßstab	Gez.	05.11.09	DI
	(C)		(D)		(F)	1:1	Gepr.
Aenderungen:	(E)	(E)	(G)	%			
 <b>IV FENSTER 68 SETZHOLZ 3-FLG DK-DK-DK</b>				K-Name: ALBRECHT			
				K-Nr.: . . .			
				<b>4 09 262 010 A</b>			

CAD



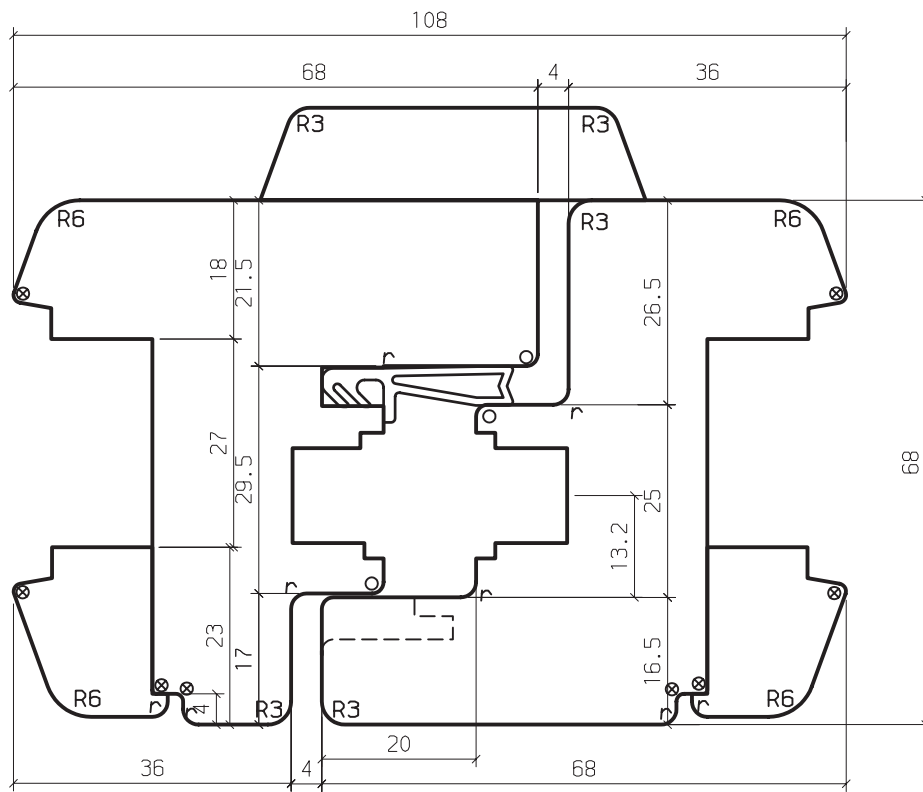

zusätzliche Optionen

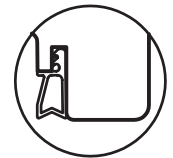

mittlere  
Überschlafdichtung

CAD

**IV FENSTER 68**  
**MITTELPARTIE RAHMENDICHTUNG**  
**AUFGESETZTE SCHLAGEIESTE**

Ers. durch:	Ers. für:	Maßstab	Gez.	05.11.09	DI
(B)	(A)	1:1	Gepr.	.	.
Aenderungen:	(D)	1:1	Gepr.	.	.
(C)	(E)	1:1	Gepr.	.	.
K-Name: ALBRECHT					
K-Nr.: . . .					
4 09 262 012 A					

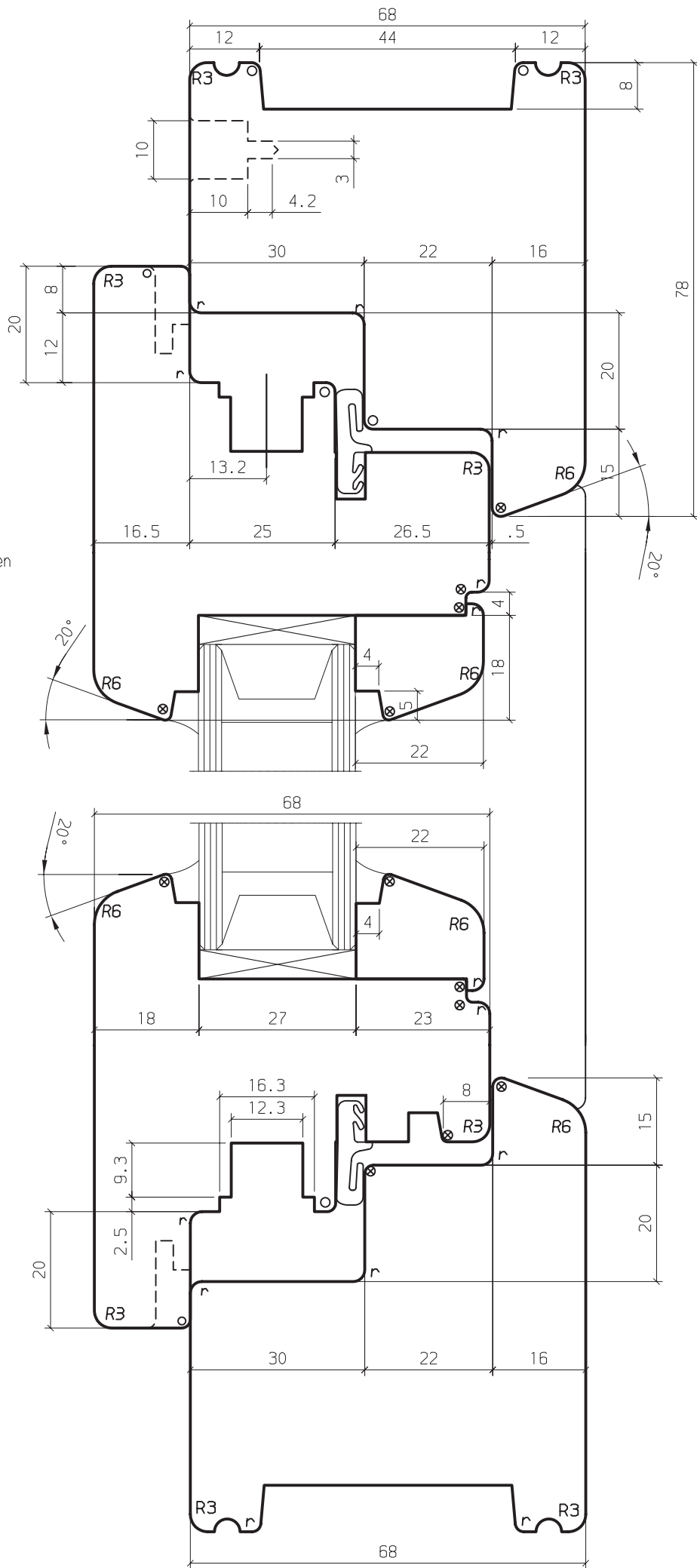

zusätzliche Optionen

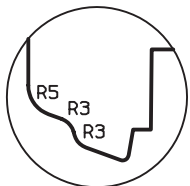

Rustikal Profil  
am Flügel

Ers. durch:	Ers. für:	Maßstab	Gez.	05.11.09	DI
			Gepr.		
Aenderungen:		1:1	1:1		
(B)	(D)	(F)	(G)		
(C)	(E)				
<b>IV FENSTER 68</b>					
<b>NACH AUSSEN ÖFFNEND</b>					
K-Name: ALBRECHT					
K-Nr.: . . .					
<b>4 09 262 013 A</b>					



CAD

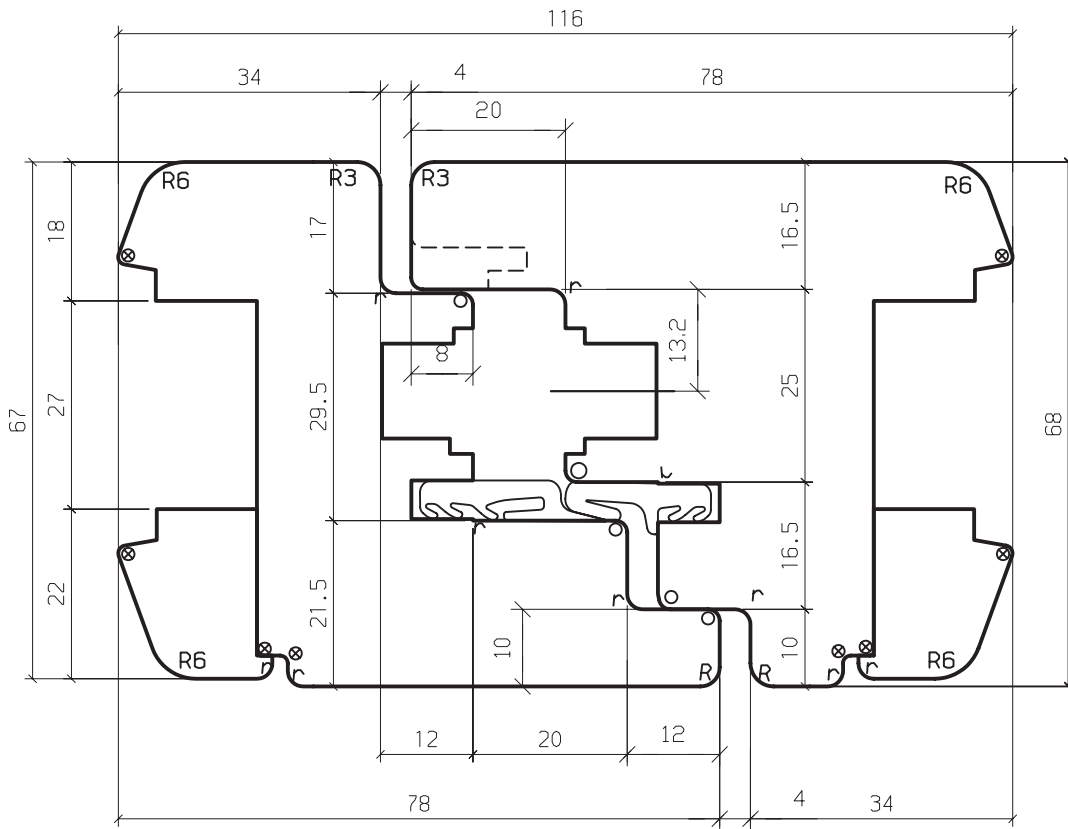

zusätzliche Optionen



mittlere  
Überschlafdichtung

Ers. durch:	(B)	Ers. für:	(A)	Maßstab	Gez.	05.11.09	DI
	(C)		(E)		1:1	Gepr.	.
Anderungen:	(D)	(F)	(G)	K-Name: ALBRECHT			
	(E)	(G)	(G)	K-Nr.: .			
 <b>IV FENSTER 68</b> <b>MITTELPARTIE</b> <b>NACH AUSSEN ÖFFNEND</b>							
CAD							
<b>4 09 262 014 A</b>							

CAD

4 09 262 014 A

